

**dbx**<sup>®</sup>  
PROFESSIONAL PRODUCTS

# QUANTUM

DIGITAL  
MASTERING  
PROCESSOR



→ *User Manual*

### Introduction

1.1 What is QUANTUM?.....	ii
1.2 Service Contact Info.....	iii
1.3 Warranty.....	iii

### Section 1 - Getting Started

1.1 Rear Panel Connections.....	2
1.2 Front Panel.....	2
1.3 Quantum Wizard.....	4
1.4 Signal Path.....	4
1.5 Mastering and the Quantum.....	5

### Section 2 - Navigation

2.1 Multiband Compressor.....	8
2.2 Broadband Compressor.....	9
2.3 Multiband Gate.....	10
2.4 Broadband Gate.....	11
2.5 Multiband Limiter.....	12
2.6 Broadband Limiter.....	13
2.7 EQ/XOVER.....	14
2.8 EQ/SEQ.....	15
2.9 Norm/Output.....	16
2.10 Other.....	17
2.11 Utility.....	18

### Section 3 - Software Operations

3.1 FX Chains.....	20
3.2 Programs/Setups.....	23
3.3 Saving a Setup.....	24
3.4 Saving a Program.....	25
3.5 The Bypass Function.....	26
3.6 Meters.....	26
3.7 Monitor Outputs.....	28

### Section 4 - Detailed Parameters

4.1 Multiband Compression.....	30
4.2 Broadband Compression.....	32
4.3 Multiband Gate.....	33
4.4 Broadband Gate.....	34
4.5 Multiband Limiting.....	35
4.6 Broadband Limiting.....	36
4.7 EQ.....	38
4.8 XOver.....	38
4.9 SEQ.....	39
4.10 Type IV™.....	40
4.11 Stereo Adjust.....	40
4.12 Ambience.....	41

4.13 TCM™.....	41
4.14 De-Esser.....	41
4.15 Normalization.....	42
4.16 Output.....	42

### Section 5 - Utilities

5.1 Input.....	46
5.2 Output.....	46
5.3 Digital Input Controls.....	47
5.4 MIDI CC Map.....	47
5.5 MIDI Channels.....	48
5.6 MIDI Program Changes.....	48
5.7 SYSEX Dump.....	48
5.8 Setup SYSEX Data.....	48
5.9 A/D Calibrate.....	49
5.10 Misc.....	49

### Section 6 - Application Guide

6.1 Analog Mastering.....	52
6.2 Digital Mastering.....	53
6.3 DAW to DAT.....	54
6.4 Analog Tracking.....	55
6.5 Digital Tracking.....	56
6.6 Analog Mixing.....	57
6.7 Digital Mixing.....	58
6.8 Analog to Digital Converter.....	59
6.9 Sample Rate Converter.....	60

### Appendix

A.1 Hard & Soft Resets.....	62
A.2 Change Default Startup Program.....	62
A.3 Front Panel Lockout.....	62
A.4 Flash Downloads.....	62
TypeIV™ White Paper.....	63
C.1 Clock Modes.....	68
C.2 QUANTUM Sync Input.....	69
SYSEX Definitions.....	71
E.1 MIDI CC - MultiBand Chains.....	74
E.2 MIDI CC - Stereo Non-MultiBand.....	75
E.3 MIDI CC - Dual Mono Chains.....	76
F.1 Factory Programs.....	78
F.2 Factory Setups.....	79
Specifications.....	80

### Figure Index

Fig. 1.1 LCD Display .....	3
Fig 1.2 Signal Path.....	4
Fig. 3.1 Stereo MultiBand Chain.....	20
Fig. 3.2 Stereo Broadband Chain .....	21
Fig. 3.3 Mono Chain Type .....	22
Fig 3.4 Stereo Setup Selection .....	23
Fig 3.5 Stereo Setup Selection .....	24
Fig 4.1 VariKnee™ .....	30
Fig 4.2 Parametric EQ Types .....	37
Fig. 4.3 Sidechain Signal Flow.....	39
Fig C.1 Sync Termination Jumper .....	69
Fig. C.2 Studio Sync Connections.....	70
Fig H.1 TPDF Dither .....	81
Fig H.2 Noise Shaping .....	82
Fig H.3 Truncation.....	83



# QUANTUM

## INTRODUCTION

# INTRO

CUSTOMER SERVICE INFO

What is QUANTUM?

WARRANTY INFO



**dbx**<sup>®</sup>

PROFESSIONAL PRODUCTS

## INTRODUCTION

Congratulations on your purchase of the dbx QUANTUM Digital Mastering Processor! For over 25 years, dbx has been the industry leader in dynamics processing. With the introduction of the QUANTUM, we apply our superior dynamics processing technology to the digital mastering process.

This manual will be your guide to understanding the full functionality of the powerful QUANTUM, read it carefully. After you have become familiar with the unit, we encourage you to experiment and find creative ways that the QUANTUM can help you make a better sounding mix.

## 1.1 What is QUANTUM?

The dbx QUANTUM is the first mastering processor that offers a sampling rate of up to 96kHz, a true 48-bit digital signal path with up to 24-bit digital output. Below are some of QUANTUM's features:

- **4 Band Stereo Gating, Compression and Limiting**
- **5 Band Parametric EQ with either an adaptive Q or a constant Q response**
- **Hi and Low shelves w/switchable slopes 3, 4.5, 6, 9, and 12 dB/octave**
- **EQ can be positioned pre dynamics, or post dynamics**
- **5 Band Parametric Side Chain EQ with either an adaptive Q or a constant Q response**
- **Dual Mono or True Stereo Operation with True RMS Power Summing™**
- **TYPE IV™ Conversion System with TSE™ Tape Saturation Emulation**
- **Normalizer – flexible gain optimization**
- **Stereo adjust – increased control of stereo imaging**
- **Dither outputs to 8,16, 20, or 24 bits, and noise shaping**
- **Sample rate conversion**
- **Sync input/output using dbx's own proprietary clock chips for extremely low jitter sync**

With the dbx TYPE IV™ Conversion System, your signal retains its analog warmth and character, with the clarity demanded by today's digital standards. Our patent-pending TSE™ Tape Saturation Emulation processing makes it easy.

The discussion of the binary system, sample rate frequencies, and bit rates, would easily take up an entire semester of college. For the sake of brevity, more is better. Theoretically 96kHz/48-bit resolution is beyond the limits our ears can perceive. The QUANTUM's 96kHz A/D-D/A's result in improved frequency response. The QUANTUM's 48-bit path gives you the "hard" and "fast" room required for a true 24-bit output. This allows the use of only 1 stage of dither at the output, where it belongs.

The engineers at dbx designed the QUANTUM to be the Rosetta Stone of digital formats, clocks, and bit rates. Whatever permutation of AES/EBU or S/PDIF is brought to you, the QUANTUM will be able to understand it and output whatever format you need.

## 1.1 What is QUANTUM? (cont.)

Imagine this scenario as an example. A client brings in a stereo mix on a sampling workstation. The mix is recorded at 96kHz/24-bit. In order to create a CD compatible mix you need to convert to 44.1kHz/16-bit. With the QUANTUM this is not a problem. Simply follow the instructions in the Application Guide in section 5. Whether you are going from the workstation to a DAW, DAT, or a stand-alone CD-R, the QUANTUM covers all the digital sample rates 96, 88.2, 48, or 44.1kHz. The QUANTUM will dither down to 24, 20, 16, or 8 bits. See the Appendix for all the possible conversions.

## 1.2 Service Contact Info

If you require technical support, contact dbx Customer Service. Be prepared to accurately describe the problem. Know the serial number of your unit - this is printed on a sticker attached to the rear panel. If you have not already taken the time to fill out your warranty registration card and send it in, please do so now.

Before you return a product to the factory for service, we recommend you refer to the manual. Make sure you have correctly followed installation steps and operation procedures. If you are still unable to solve a problem, contact our Customer Service Department at (801) 568-7660 for consultation. If you need to return a product to the factory for service, you **MUST** contact Customer Service to obtain a Return Authorization Number.

No returned products will be accepted at the factory without a Return Authorization Number.

Please refer to the Warranty below, which extends to the first end-user. After expiration of the warranty, a reasonable charge will be made for parts, labor, and packing if you choose to use the factory service facility. In all cases, you are responsible for transportation charges to the factory. dbx will pay return shipping if the unit is still under warranty.

Use the original packing material if it is available. Mark the package with the name of the shipper and with these words in red: DELICATE INSTRUMENT, FRAGILE! Insure the package properly. Ship prepaid, not collect. Do not ship parcel post.

## 1.3 Warranty

This warranty is valid only for the original purchaser and only in the United States.

1. The warranty registration card that accompanies this product must be mailed within 30 days after purchase date to validate this warranty. Proof-of-purchase is considered to be the burden of the consumer.
2. dbx warrants this product, when bought and used solely within the U.S., to be free from defects in materials and workmanship under normal use and service.
3. dbx liability under this warranty is limited to repairing or, at our discretion, replacing defective materials that show evidence of defect, provided the product is returned to dbx WITH RETURN AUTHORIZATION from the factory, where all parts and labor will be covered up to a period of two years. A Return Authorization number must be obtained from dbx by telephone. The company shall not be liable for any consequential damage as a result of the product's use in any circuit or assembly.

**1.3 Warranty (cont.)**

4. dbx reserves the right to make changes in design or make additions to or improvements upon this product without incurring any obligation to install the same additions or improvements on products previously manufactured.

5. The foregoing is in lieu of all other warranties, expressed or implied, and dbx neither assumes nor authorizes any person to assume on its behalf any obligation or liability in connection with the sale of this product. In no event shall dbx or its dealers be liable for special or consequential damages or from any delay in the performance of this warranty due to causes beyond their control.



**QUANTUM**

# Section 1

## Getting Started



**dbx**<sup>®</sup>  
PROFESSIONAL PRODUCTS

## 1.1 Rear Panel Connections



### Analog Input/Output Connectors

Each analog channel features both XLR and 1/4" TRS electronically balanced connections. They may be used in a balanced or unbalanced configuration.

### MIDI In and Out/Thru Connectors

These connectors provide full MIDI functionality to the QUANTUM. The Out/Thru jack allows you to use the QUANTUM at any point in the MIDI chain. For a complete guide to all the MIDI and SYSEX functionality of the QUANTUM, see Section 3: Software Operations.

### Sync In and Out Connectors

BNC connectors are provided for both clock in and out functions. The QUANTUM's clock chips are dbx custom VCXO chips, designed for low-jitter performance. You may use the QUANTUM as a master clock source, having other equipment slave to the QUANTUM, or you may slave the QUANTUM's clock to any other source device. For more information on the QUANTUM's sync functions see Sync in the Utilities section.

### S/PDIF Digital Connectors (see Utility Section)

The QUANTUM provides S/PDIF digital input and output through the RCA connectors on the rear panel. The analog outputs still operate regardless of the selection of the digital output format.

### AES/EBU Digital Connectors

XLR connectors provide AES/EBU input and output.

### IEC Power Cord Receptacle

The QUANTUM comes with an International power supply that will accept voltages ranging from 100V-240V at frequencies from 50Hz-60Hz. An IEC cord is included.

## 1.2 Front Panel

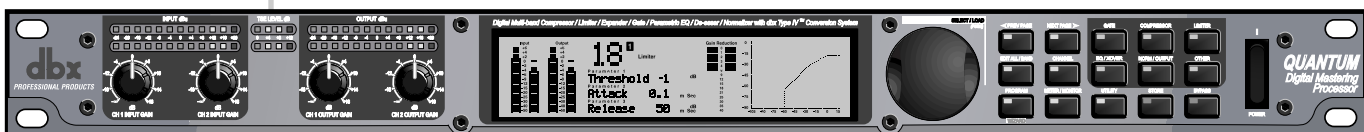

### Analog Input and Output Level Controls

These controls adjust the analog audio levels of the QUANTUM at the input and output stages. Note that the analog output level controls do not affect any digital processing or digital output levels.

The QUANTUM is designed to interface as easily as possible to your system. The QUANTUM uses wide ranging analog input and output gain controls. These controls allow the connection of nominal levels of either -10dBV or +4dBu.

### 1.2 Front Panel (cont.)

#### Analog Level Meters

These meters monitor analog input and output. For more on meters refer to Section 3.

#### TSE™ Audio Level Meters

These meters monitor the level of Tape Saturation Emulation. Refer to Type IV™ in Section 3.

#### LCD Display

The large LCD display shows the program, curve, digital meters, parameters, and modules selected by the function buttons and the DATA WHEEL.

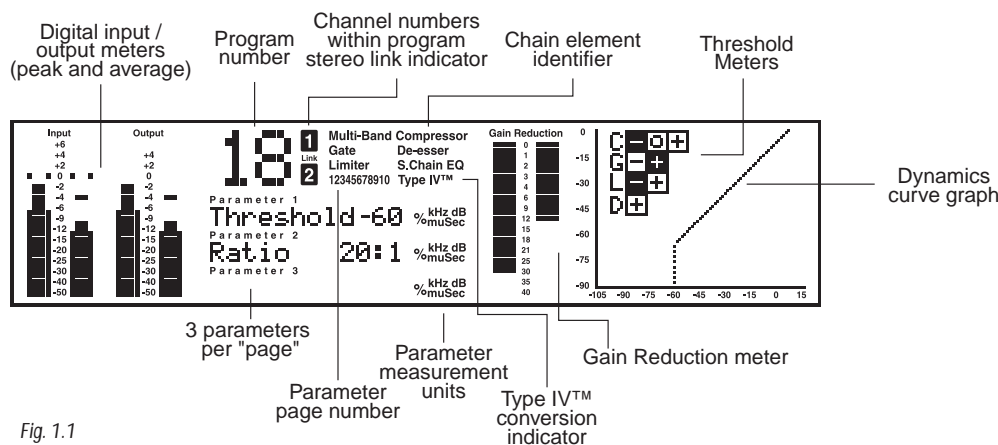

Fig. 1.1

#### Data Wheel / Selector

The DATA WHEEL changes selected parameters, programs, etc. Pushing the DATA WHEEL moves the cursor from parameter to parameter.

#### Function Buttons

The function buttons allow access to the programs, modules, utilities, and parameters of the QUANTUM.

#### Power Switch

Turns the QUANTUM on and off.

#### The Curve Window

After you have chosen a program, you may want to change some of the parameters to meet your specific needs. One of the most useful tools available on the QUANTUM for setting up a proper compression curve is the curve window. In the curve window you can see the combined effects of dynamics-related parameters expressed in a graphical format. The figure below shows the different parts of the curve window you will see as you edit the gate, compressor, and limiter functions of the QUANTUM.

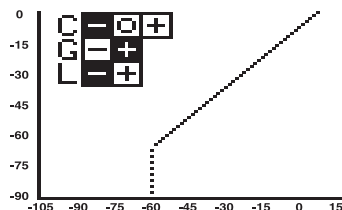

## 1.2 Front Panel (cont.)

When working with the sidechain EQ, or the in-line EQ, the curve window changes to show a graphical representation of the 5 parametric bands in a frequency grid. Your adjustments to the 5 bands are shown in real time.

Additionally, the De-Esser has its own graphical way of displaying its parameters. The frequency is shown on the bottom, or X axis, and the low frequency rolloff is shown on the side, or Y axis.

## 1.3 QUANTUM Wizard

The easiest way to program the QUANTUM is using the Wizard. To access the Wizard, press and hold the PROGRAM button.

Once in the Wizard mode, you will select the task that you are performing. The QUANTUM will automatically choose the correct chain type for your task. If you select Mastering or Mixing, the Wizard will then have you choose your music type. After you have selected the music type, you will then select the type of EQ, gating, compression, and limiting. These are all influenced by the music type. For example, a "Light" compression setting with the music type set to "Hard Rock" will be heavier than "Heavy" compression with the music type set to "Classical".

If you select "Tracking", then you will be asked to set up either channel one, channel two, or stereo. If you are tracking two separate instruments in dual mono, then you can go through the Wizard twice, the first time setting up channel one and the second time setting up channel two. If at any time you decide you want to quit without the Wizard setting up a program for you, you may press the PROGRAM button to exit the Wizard.

Once all of the questions have been answered, the QUANTUM will display "WORKING..." and then a custom setup will appear tailored to your application. If you are working in a stereo setup, the QUANTUM will allow you to optimize your output gain. To optimize the output gain, push the EDIT ALL/BAND button while the loudest part of the program material is passing through the Quantum. Press the button again when the peak has passed. The Wizard will optimize the output level so that the highest peak is set to 0 dBFS. The Wizard will then return you to the Program mode. If the PROGRAM button is pressed while gain optimizing, the Wizard will exit without changing the output level. This setup can be further adapted to your taste and saved for later use.

## 1.4 Signal Path

The following illustration shows how audio signals flow through the QUANTUM.

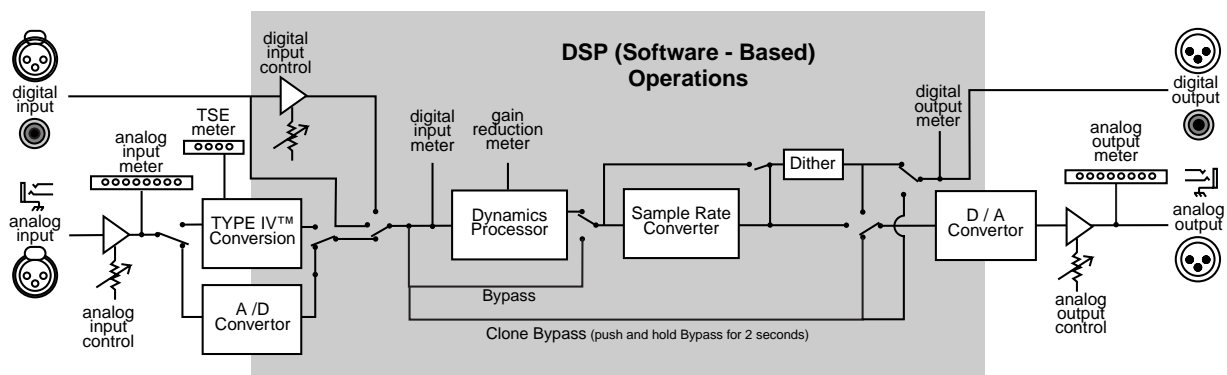

Fig 1.2

## 1.5 Mastering and the Quantum

The Quantum is a Mastering Processor that has many features:

- **Multiband compression**
- **Multiband gating**
- **Multiband limiting**
- **Parametric equalizer**
- **Normalize function with gain optimization**
- **8-24-bit dither with noise shaping**

These tools used together can give your recording studio the power to create the big sound associated with a mastered recording.

Traditionally, mastering was accomplished by a combination of compression and equalization. Specifically, multiband compression was used to allow the mastering engineer to control the dynamics of the mix without making the recording seem lifeless. The QUANTUM has four bands of multiband compression.

Multiband compression is a three-step process. First, a crossover is used to separate the audio into different frequency bands. Next, separate compressors process the individual bands. Finally, the bands are summed back together. Because these bands contain different amounts of energy, they can be compressed using widely varying settings. The end result is that parts of the mix, the low frequency bands for example, can be compressed more heavily than if a single compressor was used on the entire mix; thereby, allowing a greater overall level and a "hotter" mix.

The easiest way of setting up the multiband compressor in QUANTUM, is to use the monitor in conjunction with the crossover and the compressor.

For example, assume that you had a rock mix that you wanted to master. Specifically, you want to compress the kick and bass parts to create a more "punchy" mix. You also want to control the vocals to keep them from being too prominent in the mix. The first thing you would do is to set up the crossover so that most of the low frequency energy of the kick and bass is in the sub and low bands. The vocal band should also be separated from the other bands.

*The Monitor page allows the engineer to toggle the monitor position between the main L/R and individual bands both pre and post processing. By rotating the DATA WHEEL, the monitor position is changed.*

As you listen to the bands you realize that Band two has too much of the vocal in it, so crossover band two should be adjusted to a lower frequency.

*The crossover page shows the crossover points as well as their slopes. The crossover points can be adjusted by rotating the DATA WHEEL and using the NEXT PAGE and PREV PAGE buttons to move between different crossover points. The slope can be changed by, pushing the DATA WHEEL to move to the slope parameter line. Turning the DATA WHEEL changes the slope of the crossover. Changing the crossover slope changes the way the frequency bands interact. For example, a broader slope, e.g. 6 dB/Octave, allows the adjacent bands to have much more interaction than a slope of 18 dB/Octave. Broader slopes provide a more seamless transition between bands, while steeper slopes allow tighter control over a particular band.*

## 1.5 Mastering and the Quantum (cont.)

Now that your bands are set up for your application, you monitor them and you hear how the sub-band (band one), is the ultra-low frequencies of the kick and bass as well as some of the guitar. The low band (band two), includes the electric and acoustic guitars, the bass, and some of the low vocal frequencies. The Mid band, (band three), contains the majority of the vocals as well as the mid range frequencies of the Mid band guitar. The high band (band four), contains the cymbals, the click of the guitar pick on the acoustic guitar, and the higher vocal frequencies. You are now ready to go to the compressor and start compressing your mix.

Setting up your compressor is similar to setting up your crossover, in that you can go and listen to how the compression is affecting the individual bands by monitoring them both pre and post processing.

*The Compressor page gives the engineer control over all the parameters that are needed to adjust the multiband compressor. The Multiband compressor can be adjusted either as a unit or the individual bands can be adjusted separately. By pushing the DATA WHEEL, the different parameters on a page can be adjusted, and by pushing the NEXT PAGE and PREV PAGE buttons all the compressor parameters can be accessed. (for a complete list of compressor parameters see Section 3, Software Operations). The different bands of the multiband compressor can be accessed by either using the EDIT ALL/BAND button or by pushing the compressor button. Each additional push of the compressor button allows access to the next band.*

Setting up your compressor you decide to compress bands one and two with a ratio of 3:1. You set the threshold for band one at  $-22$  dBFS and the threshold for band two you set to  $-20$  dBFS. (Remember that in multiband compression, the individual bands have less energy than the overall mix, so the compression threshold must be lower.) These settings seem to work well for bands one and two if the gain is set to 4.5 dB for band one and 3.5 dB for band two. Band three requires less compression to control it so you set the ratio to 1.5:1 with the threshold set to  $-26$  dBFS and the gain to 2.0 dB. The high frequencies require a little compression to keep them in line with the rest of the mix so you set band four's ratio to 2:1 with the threshold set to  $-30$  dBFS and the gain set to 1.0 dB. As you listen to your mix, you realize that the vocals could use a little more compression so you change the ratio of band three to 1.8:1. It is important to listen to both the individual bands and the mix as a whole to hear how the compression is affecting the entire mix. This type of procedure should be duplicated on the multiband gate and the multiband limiter to achieve the best results.

As you have seen, setting up the multiband compressor is an iterative process that takes time to perfect. By using the multiband compressor along with the other tools available in QUANTUM you will be able to create much larger sounding mixes and masters.



### NAVIGATION

Control of each of the bands within the QUANTUM's multiband dynamic modules is made possible in two different ways. You may either use the "All page" or individual band adjustments. The "All page" is signified by a large "All" seen where the program number would normally be. Adjusting settings in this page will adjust the settings in all four bands as a group. To control individual bands within the "All page" press the EDIT ALL/BAND button to cycle through each band. Pressing the dynamic module's button again will cycle you through the separate bands and the dynamic controls of those bands e.g., compressor or limiter.

Refer to the Navigation illustrations for a complete view of the parameters available in each Multiband Dynamic Module.

## 2.1 Multiband Compressor

### Navigating the "Multiband Compressor"

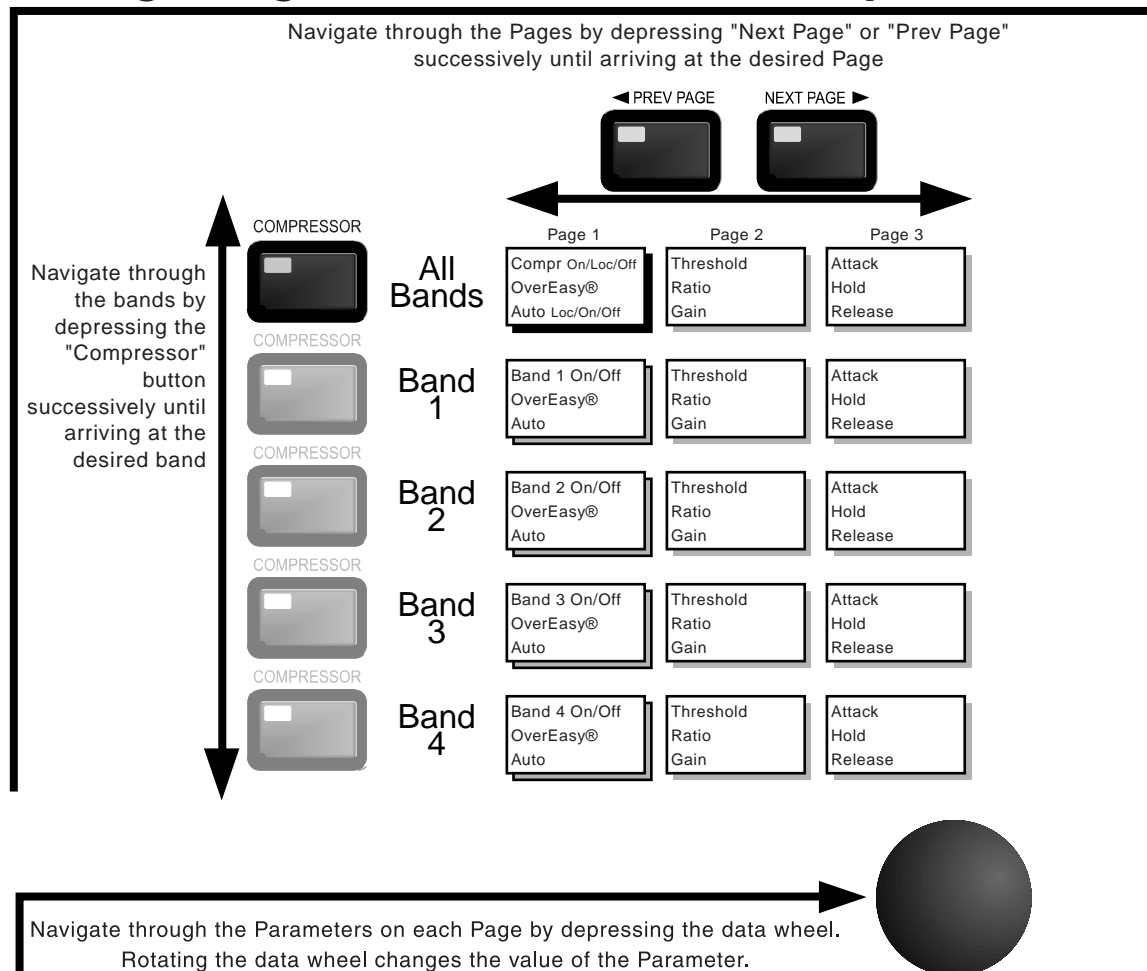



2.2 Broadband Compressor

# Navigating the "Broadband Compressor"

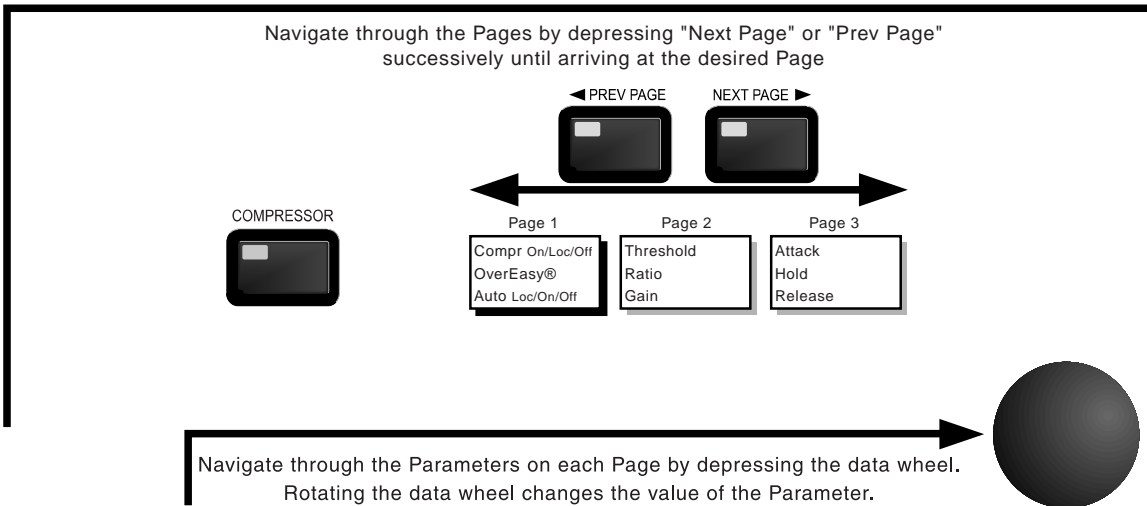

### 2.3 Multiband Gate

## Navigating the "Multiband Gate"

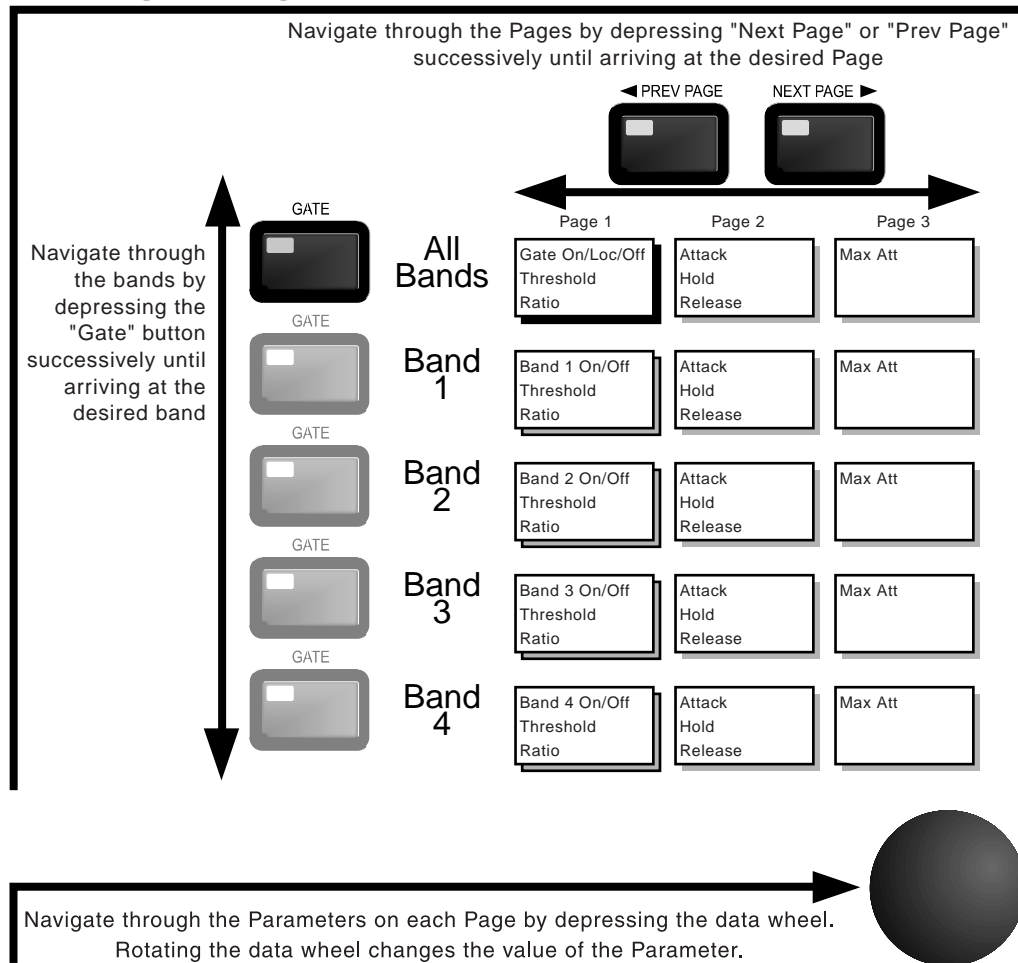

2.4 Broadband Gate

# Navigating the "Broadband Gate"

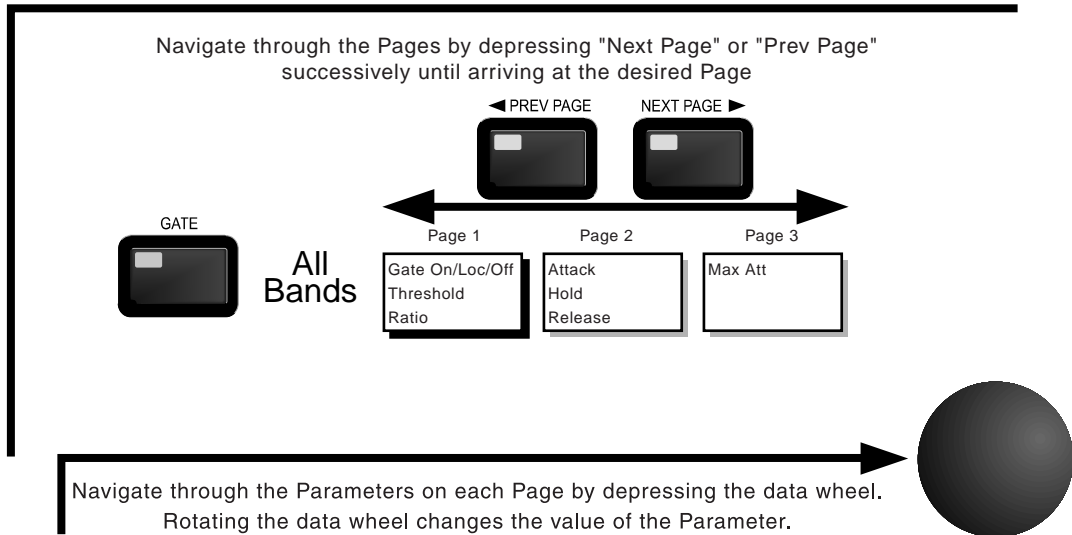

2.5 Multiband Limiter

## Navigating the "Multiband Limiter"

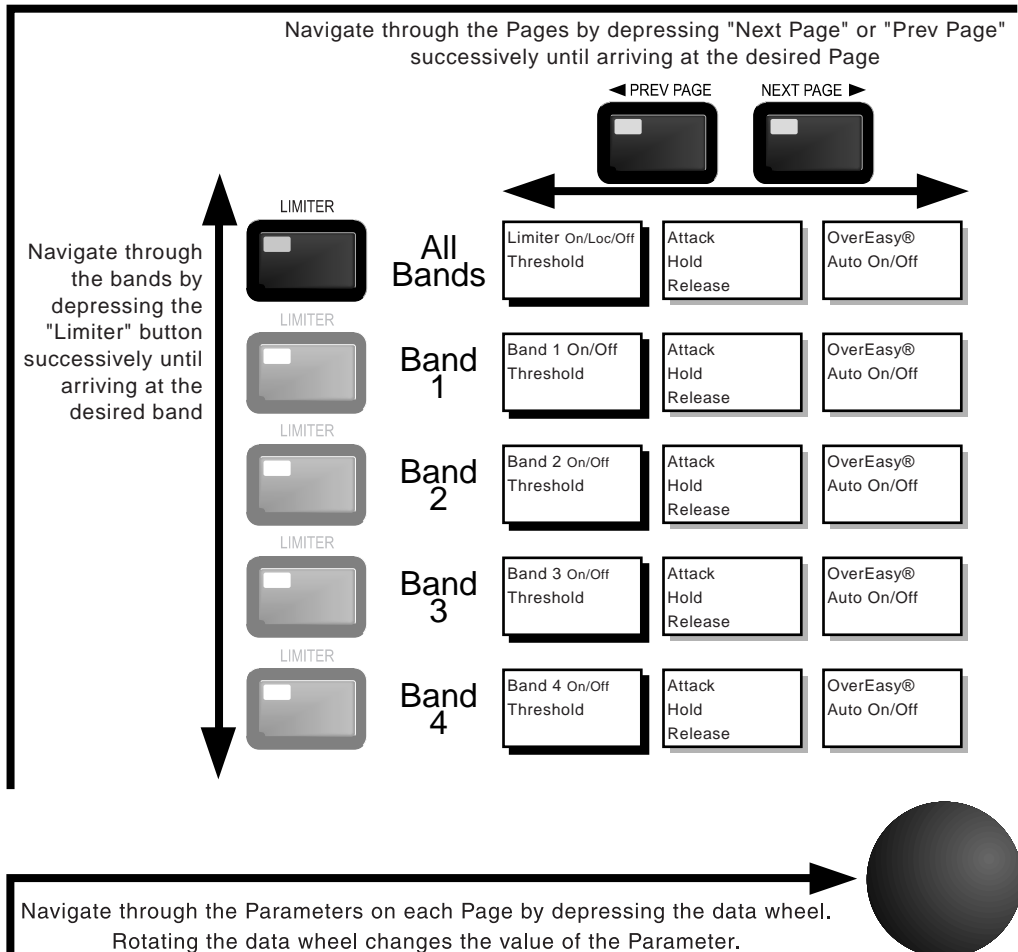

2.6 Broadband Limiter

# Navigating the "Broadband Limiter"

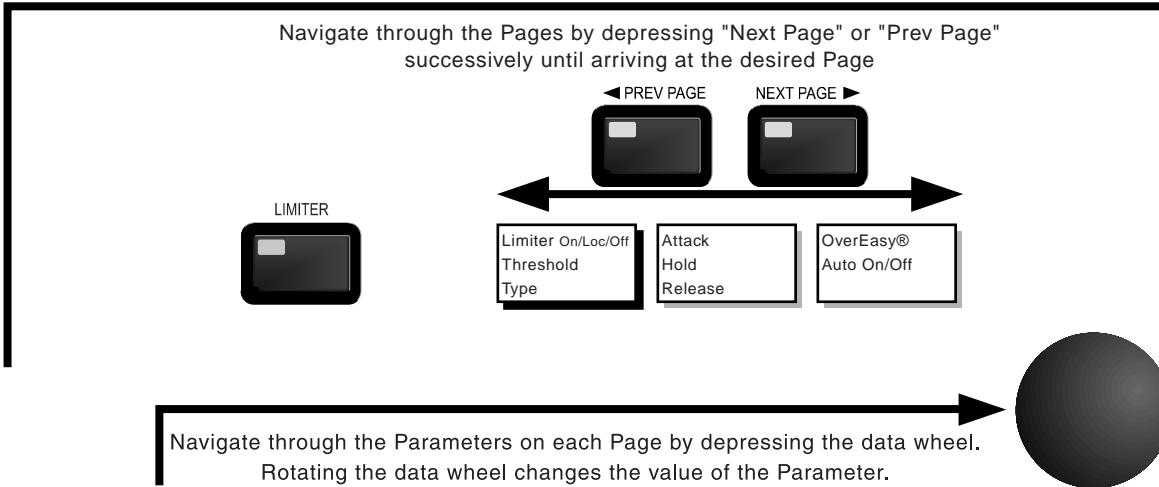

2.7 EQ/XOver

# Navigating the "Multiband EQ/XOver"

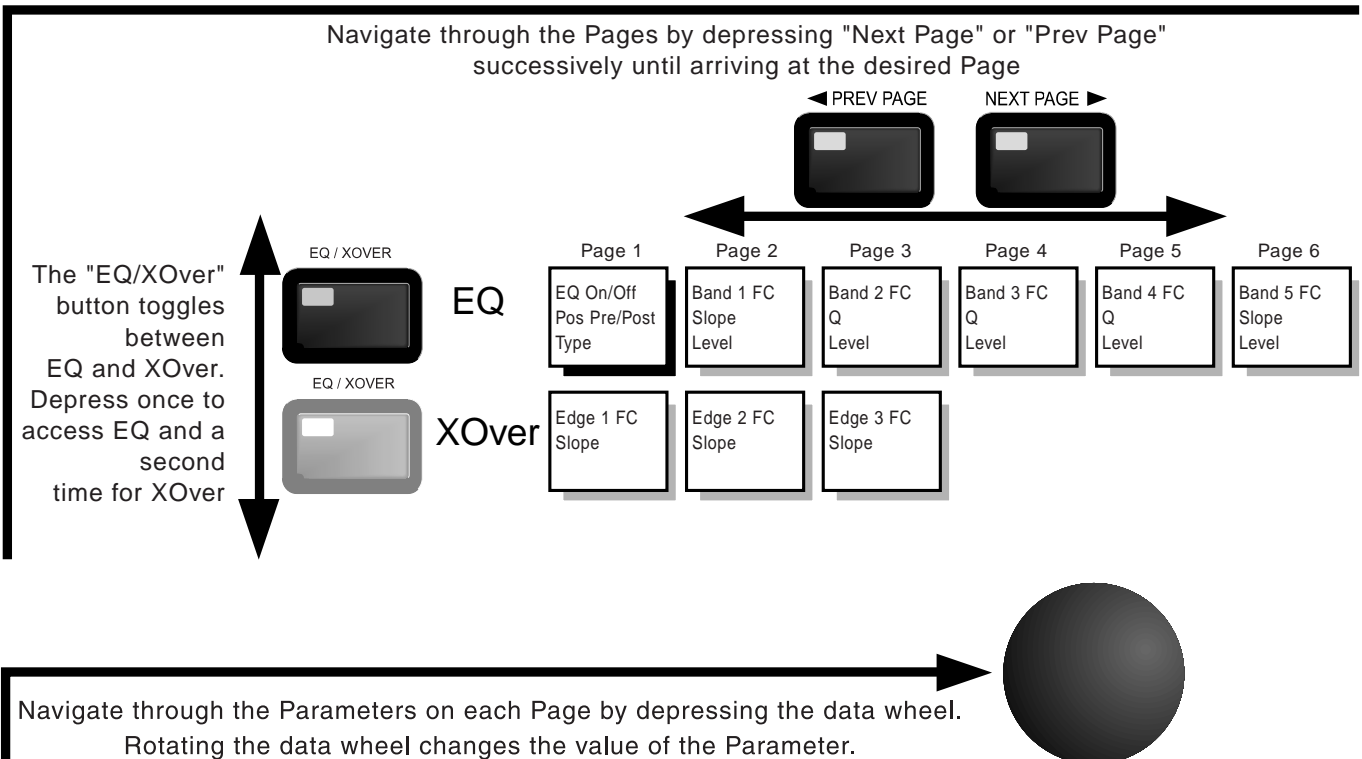

## 2.8 EQ/SEQ

### Navigating the "Broadband EQ/SEQ"

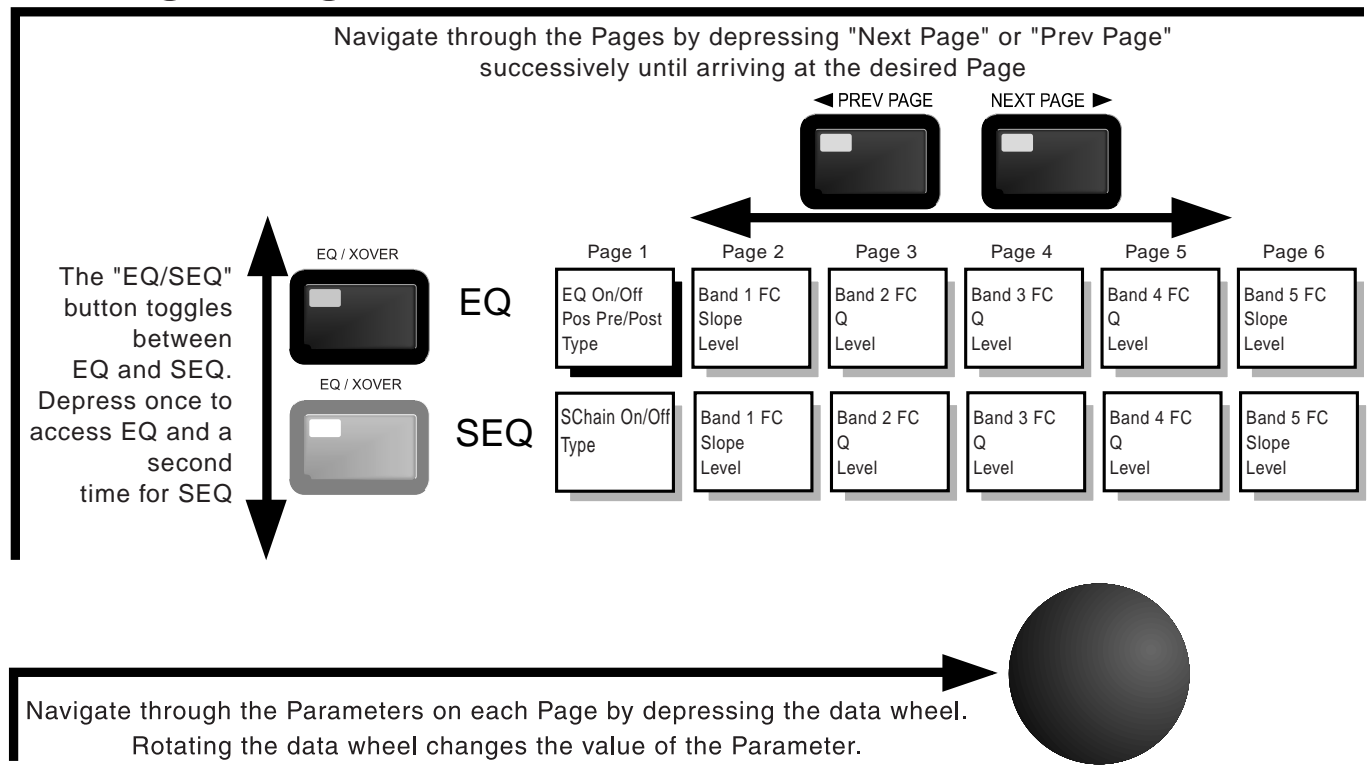

2.9 Norm/Output

# Navigating "Norm/Output"

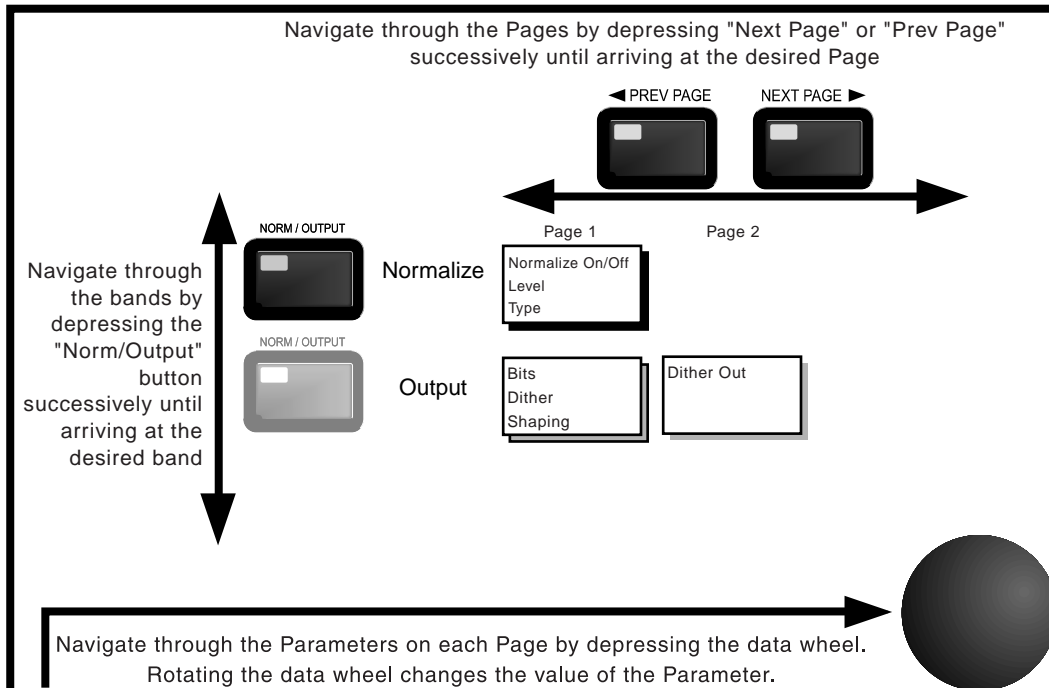



## 2.10 Other

### Navigating "Other"

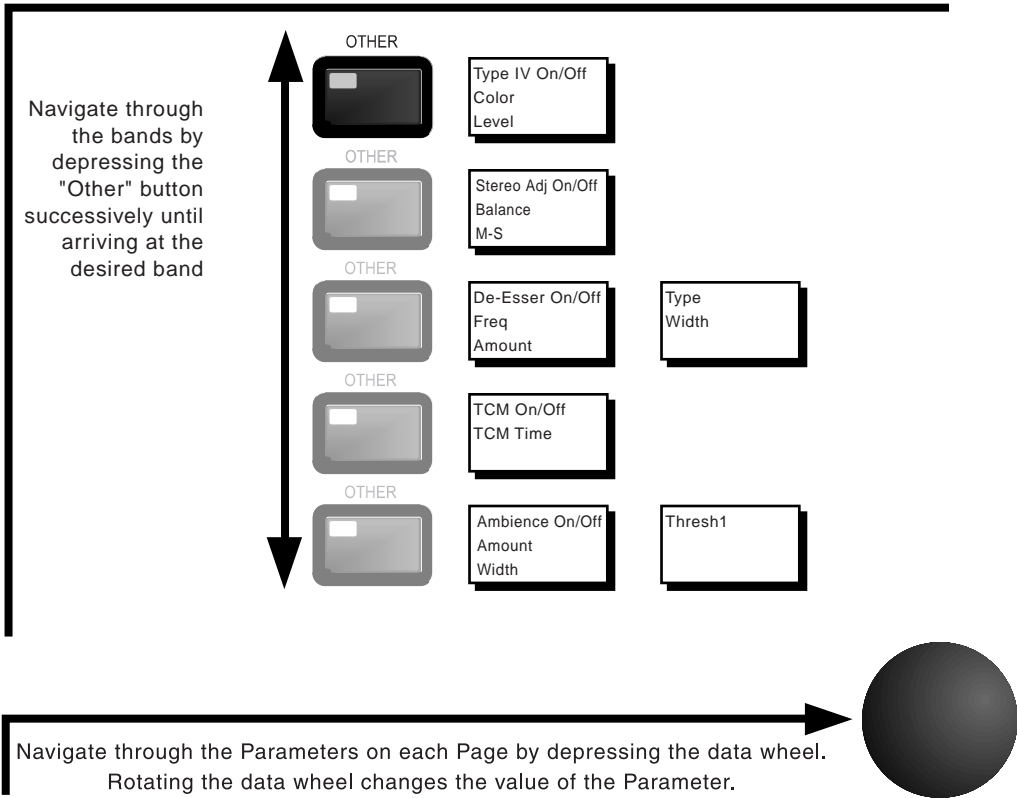

## 2.11 Utility

## Navigating "Utility"

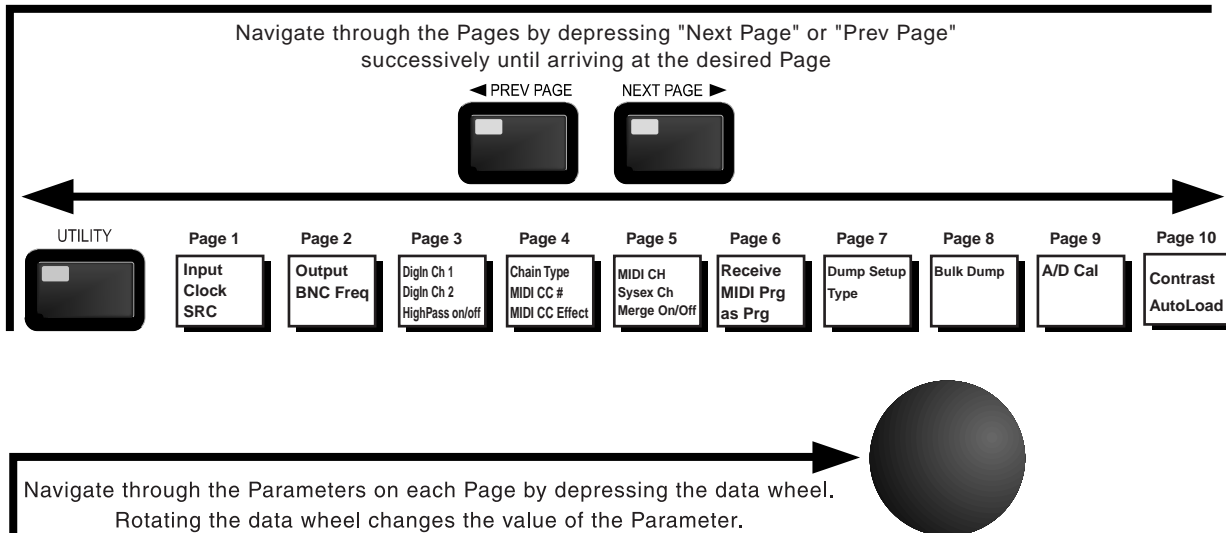

**QUANTUM**

# Section 3

**SOFTWARE**

## SOFTWARE OPERATIONS



**dbx<sup>®</sup>**

**PROFESSIONAL PRODUCTS**

### SOFTWARE OPERATIONS

This section explains how signals are routed, monitored, and controlled in the QUANTUM. Changes that are made to the QUANTUM's dynamic processing can be monitored visually and aurally at several different points in the chain. Storing, and organizing user and factory setups in task specific libraries is also covered in this section. By following the outlined steps you will quickly understand the usage and benefits of the QUANTUM's storage system.

### 3.1 FX Chains

The following charts show the signal flow through the QUANTUM's FX chains. Note that the location of the parametric EQ (PEQ) changes according to Pre/Post settings.

#### Chain Type: Stereo Multi Band

PEQ may be Pre or Post Dynamics

What the QUANTUM screen shows for Pre:

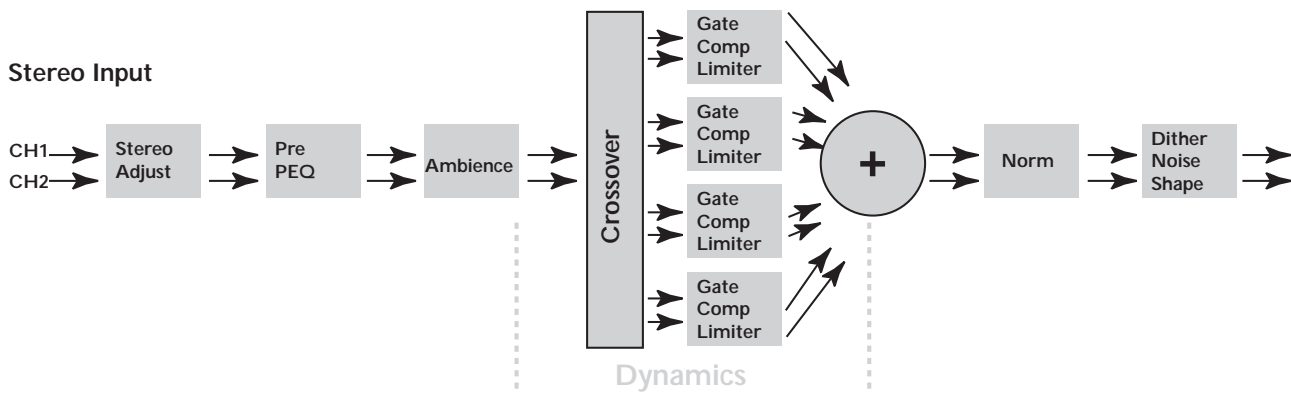
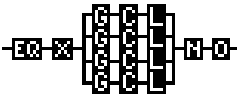

What the QUANTUM screen shows for Post:

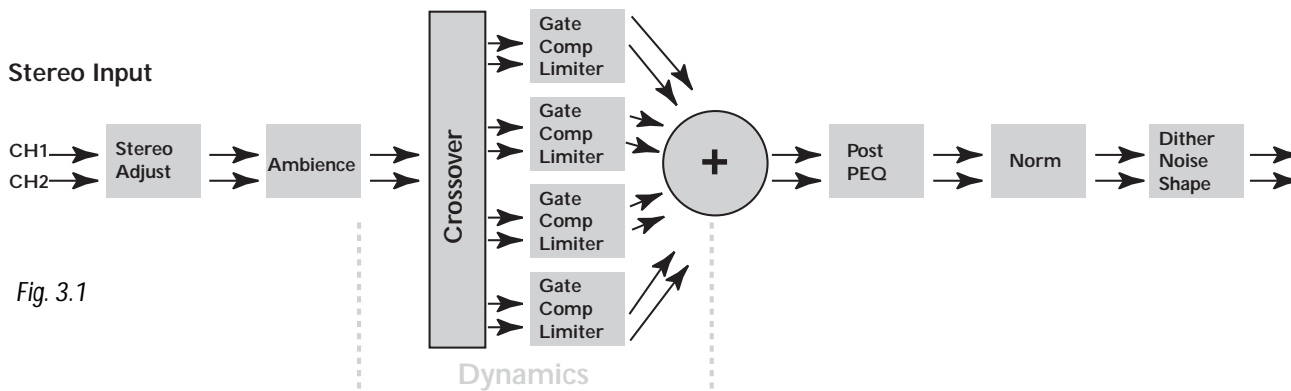
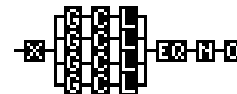
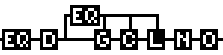

Fig. 3.1

### 3.1 FX Chains (cont.)

#### Chain Type: Stereo Broadband

PEQ may be Pre or Post Dynamics

What the QUANTUM screen shows for Pre: 

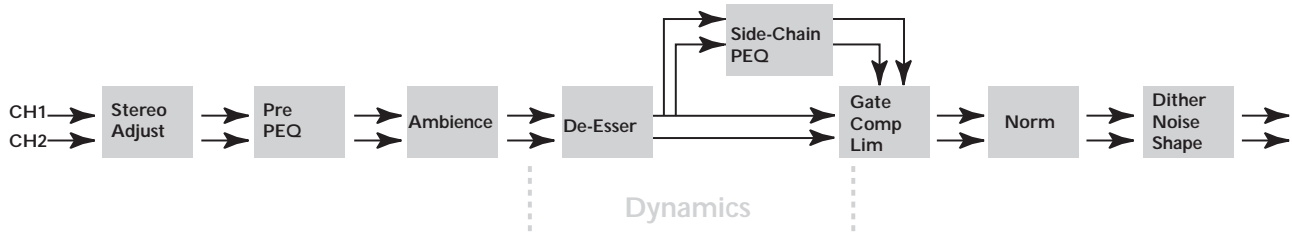

What the QUANTUM screen shows for Post: 

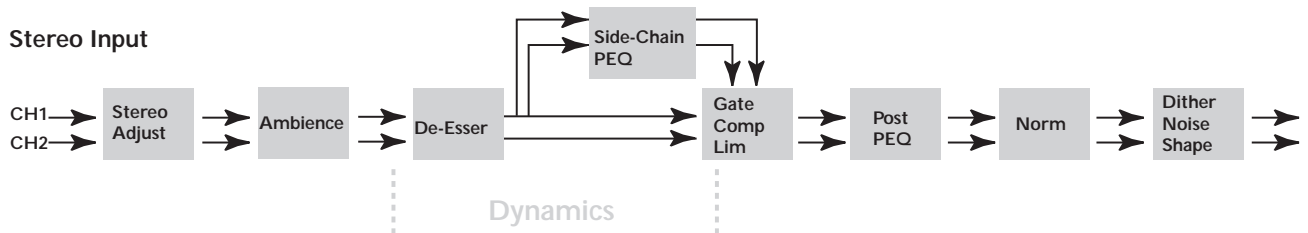

Fig 3.2

### 3.1 FX Chains (cont.)

#### Chain Type: Mono

PEQ may be Pre or Post Dynamics

What the QUANTUM screen shows for Pre:

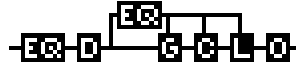

Mono Input  
CH1 or CH2

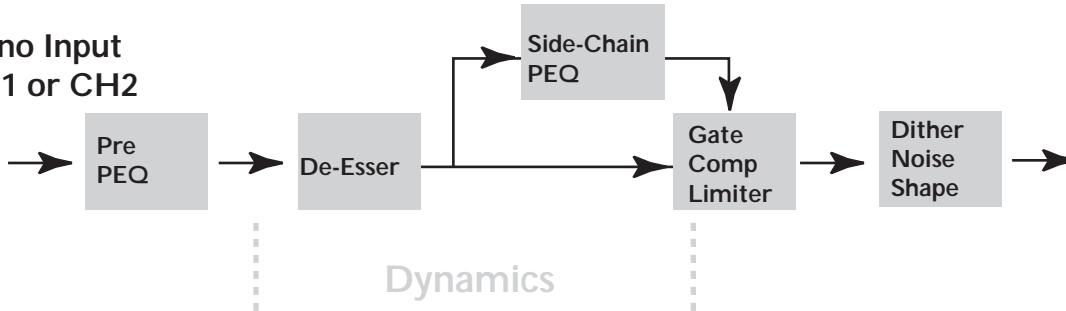

What the QUANTUM screen shows for Post:

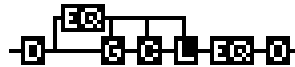

Mono Input  
CH1 or CH2

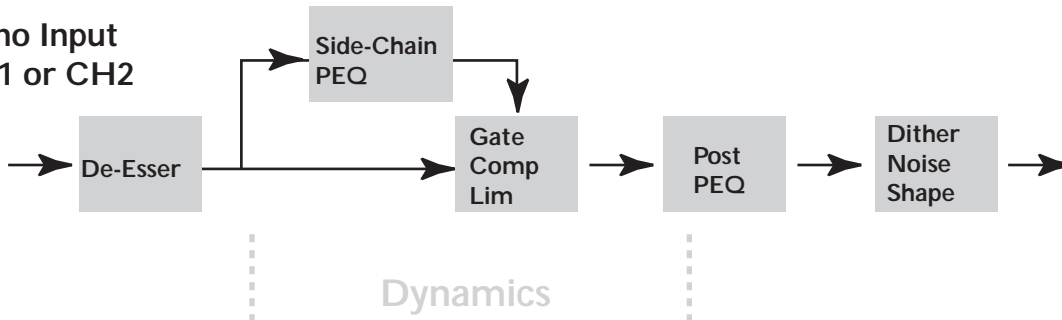

Fig. 3.3

### 3.2 Programs/Setups

The QUANTUM has a unique method of storing your settings. It stores your changes to parameters as setups. These setups are an immediately accessible library of your changes. No matter what program you are currently working with, you can call up any setup that uses that same configuration: stereo-linked or dual mono. (See Appendix F). Each configuration has its own separate library of user/factory setups available. This allows you to stay in a program but still change the setups within that program. The easiest way to demonstrate this is by using a dual mono program.

Imagine that you have the perfect settings for a kick drum dialed in on channel one, but you need to find a better setup for the snare. The CHANNEL button will toggle you between channels 1&2. You are now able to browse the setup library by using the DATA WHEEL. When you have found a setup that is closest to what you need, press PROGRAM. The changes that have been made are now waiting to be saved as a program, and the STORE light will be lit. Another helpful feature of this library system is that you may place your stored setups anywhere you like within your library. If you choose "Store New" from the "Store" menu, you may then choose the position of your setup within your library. To do this, simply spin the DATA WHEEL to re-order your setup library. This allows you to keep your setups organized how you want them. For example, you can keep all of your "Hard Rock" or "Jazz" setups together for quick recall and editing. See the Setup Selection illustrations 3.4 and 3.5.

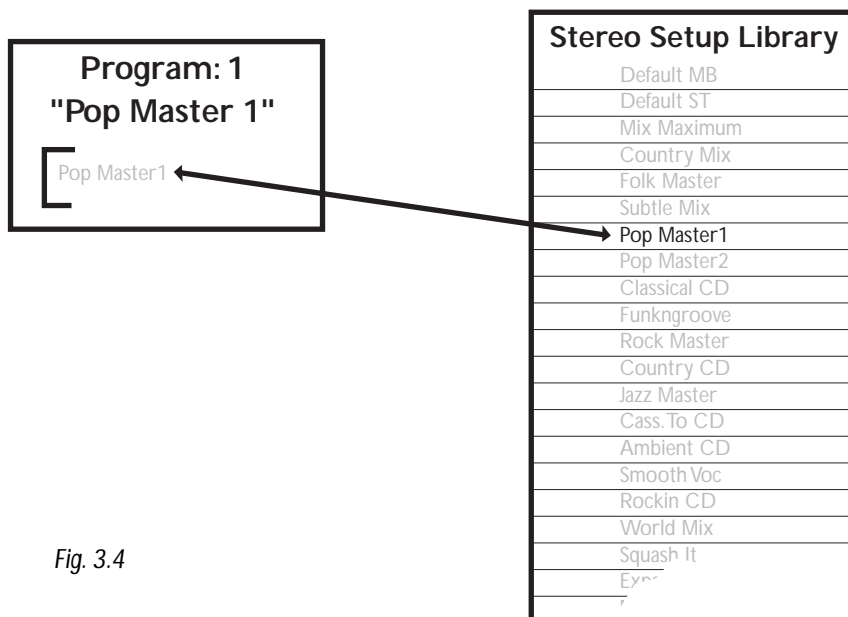

Fig. 3.4

### 3.2 Programs/Setups (cont.)

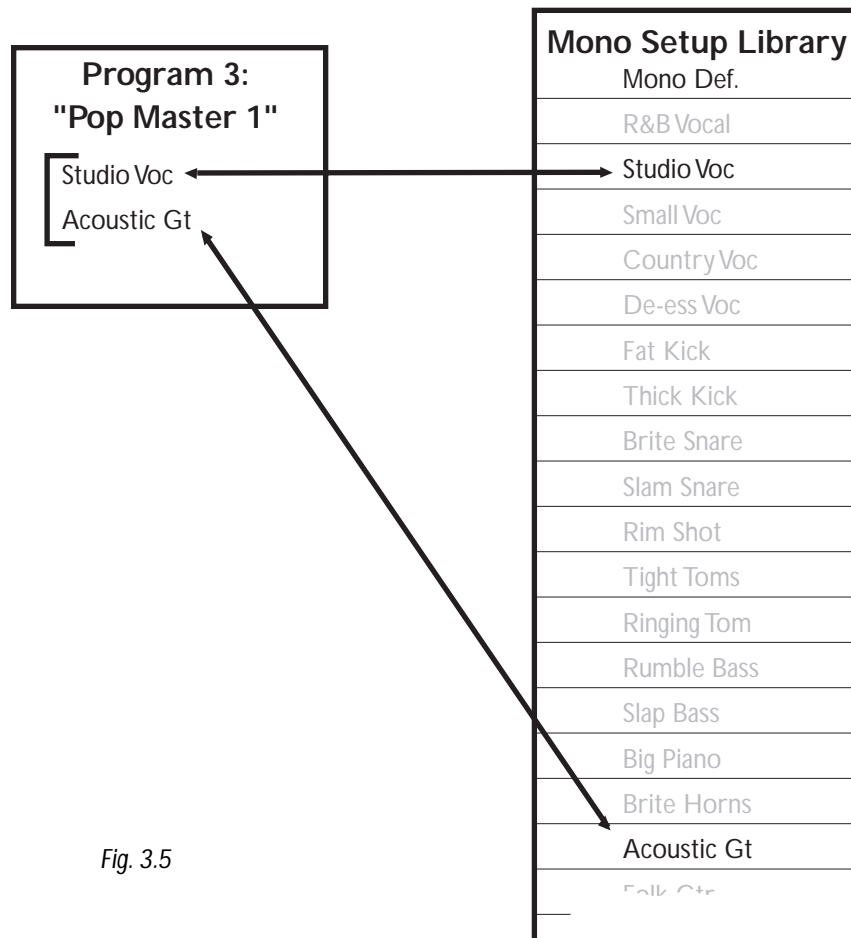

Fig. 3.5

### 3.3 Saving a Setup

Saving a setup can be done by following these steps:

1. After you have edited your setups to your liking, press the STORE button. The screen will look like the figure below. Pressing the DATA WHEEL move the cursor down to either CH 1 Setup, or CH 2 Setup, if you have been editing a dual mono program. If you have been working with a linked program, your second choice will be "Link Setup". Make your selection by pressing the STORE button again. Remember that there is room in the QUANTUM to store 50 linked setups and 50 mono setups, in addition to the factory setups.





### 3.3 Saving a Setup (cont.)

- To name your setup, there are instructions for you in the Curve Window. Press STORE when you are done.
- You now must choose what you want to do with the setup you are going to save. You have two choices: you may write over another setup, or you may make a new one.

#### Replace Old:

Notice that as you write over an old setup, all other programs will now recall the newly saved setup.

To replace an old setup, move the cursor to the “Replace Old” choice and press STORE. You are given a choice of which setup to replace. Using the DATA WHEEL scroll to the name of the setup you wish to replace.

*Notice that as you replace a setup, all other programs that recall that setup will now recall the newly saved setup using the new setup name.*

#### Store New:

- To store a new setup, choose “Store New” after pressing the STORE button. After you are done, press STORE once again. You now must choose a place for the new setup to be placed in the library. The name of your new setup is displayed on the middle line of text (the “Parameter 2” line).
- Use the DATA WHEEL to scroll to the place where you want to add the new setup. The QUANTUM “makes room” for your setup, no matter where you want to place it.

### 3.4 Saving a Program

#### Saving a program

Saving a program is done by following these steps:

- Press the STORE button. The screen looks like this.



- You have the choice of saving the Program, or saving the setup. Choose the first option by simply pressing the STORE button.
- As you do this, the screen goes to the next “Store Page”, asking you to name the new program. The “curve window” shows instructions. Using the DATA WHEEL as a “selector” and the Page Up / Page Down buttons as the cursor, create the name you want to use, then press the store button to save the name.
- When you have named the new program, press STORE again, then select a new location (1-50), the screen bumps to the next save screen, asking you to select a program for the QUANTUM to erase and write the new program over. Note that you can only access programs 1-50.

### 3.5 The Bypass Function

#### BYPASS

To bypass the QUANTUM press the BYPASS button once. All digital dynamic modules are rendered inactive.

The QUANTUM also has a CLONE BYPASS mode, passes the digital audio through the QUANTUM to the digital output directly as it came in—a digital clone. To use the CLONE BYPASS mode, simply press and hold the BYPASS button for 2 seconds. All other function buttons cannot be accessed until the BYPASS button is pressed again. The TYPE IV™ Conversion is still active in some bypass modes to protect against digital clip. If TYPE IV™ were shut off with bypass, then a signal that enters TSE™ would cause audible clipping.

The following list may help clarify:

BYPASS with ANALOG INPUT, the dither and TYPE IV™ will still be active.

BYPASS with DIGITAL INPUT, digital input levels, the high pass and the dither will still be active.

CLONE BYPASS with ANALOG INPUT, TYPE IV™ will still be active but uneditable.

CLONE BYPASS with DIGITAL INPUT, is an exact output of the input, nothing will be active.

### 3.6 Meters

#### Analog Meters

The QUANTUM's analog input meters show the signal after the input controls. These analog meters are referenced in dBu. The meter will accurately represent the input level only when the input controls are set to zero.

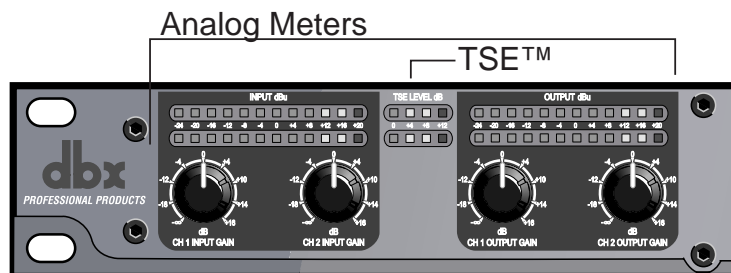

#### TSE™ Level Meters

These meters show that the program material has entered into Tape Saturation Emulation. They will only operate if TYPE IV™ is ON. The “0” will light when the program material has entered into TSE™. Increments of 4dB steps show the increasing entry into TSE™. A general usage of TSE™ is: 0-4dB vocals, 4-8dB guitar, 8-12dB drums/highly transient material. Of course, the use of TSE™ is highly subjective.

### 3.6 Meters (cont.)

#### Digital Meters

The middle portion of the meter represents the peak level of the signal. The sides of the meter represent the average peak level. Since the digital output meter is located after dither, changes made to dither will be seen at this meter. Digital clipping is represented by a large "C" at the top of the meter.

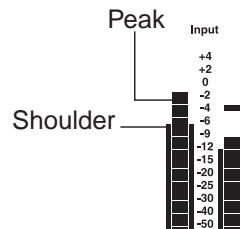

The Gain Reduction meters are a measurement of the sum of all active dynamic modules. In multiband mode, the meters function a little differently. Each LCD segment represents a separate band. This allows an accurate meter representation of the signal at a glance.

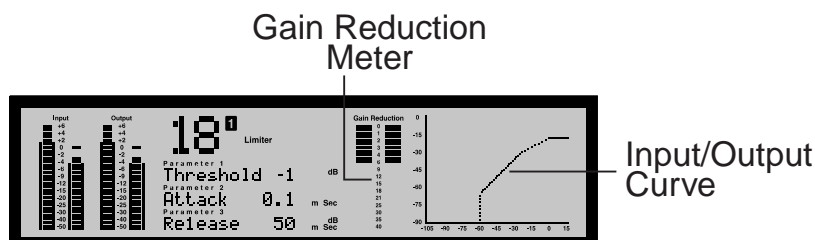

#### Meter Options

Two different meter options are available. By pushing the METER/MONITOR button your choice of a High Resolution dBFS Output meter w/clip counter, or a Gate, Compressor, and Limiter threshold meter are available. The Gate, Compressor, and Limiter threshold meters shows if your signal has reached the threshold set in each dynamic processor. This is indicated by +/- symbols.

On every program, you will find threshold metering for each processing element.

#### Compressor

For the compressor, the threshold meter has three segments. The first is the minus (-) sign. It indicates that the threshold set in the compressor section is not being exceeded by the program material. There is no processing taking place in the compressor section if the threshold is not being exceeded, no matter what the other compressor settings are. The next part of the threshold meter is the "o". It represents the OverEasy® range of compression. When the signal level is in the OverEasy® range, the "o" part of the meter will be blackened, indicating that the signal is in the OverEasy® mode of compression. (For a complete explanation of the OverEasy® parameter, see Section 4.) The third segment of the compressor meter is the plus (+) sign. It is blackened when the signal is being fully compressed at the ratio set by the Ratio Parameter.

### 3.6 Meters (cont.)

#### Limiter

The limiter's threshold meter works on the same principle. When the signal is under the threshold setting, the signal is not being processed by the limiter section. The next part of the threshold meter is the "o". It represents the OverEasy® range of compression. When the signal exceeds the threshold set in the limiter section, the plus (+) sign will darken, and gain reduction will begin to occur as a result of the signal exceeding the limiter's threshold.

#### Gate / Expander

When the signal is under the threshold set in the gate section, the gate is "closed", or signal is being attenuated. When the signal is under the threshold, the minus (-) sign is darkened, and when the signal passes over the threshold, the plus (+) sign is darkened.

#### De-Esser

The De-esser also has a threshold meter. The threshold meter for this element is also displayed in the upper left corner. When the plus sign is darkened, the threshold has been exceeded and De-Essing is being applied to the signal.

### 3.7 Monitor Outputs

Monitoring separate bands is a useful and easily accomplished function in the QUANTUM. By pressing the METER/MONITOR button twice you are able to access the monitor selection page. Use the DATA WHEEL to select at which point you would like to monitor. The headphone graphic and arrow change to show the point in the signal chain you are monitoring. The text under "Monitor Out" shows which band and position you are currently selecting. **This is a very important option.** As you are adjusting dynamic processing within individual bands it helps to monitor the changes made to those bands. "Band 1 pre" monitor position is located just after the crossover, before the gate, compressor, and limiter. "Band 1 post" is located after the gate, compressor, and limiter, before the Normalizer and output. The other bands (2-4) operate in the same fashion.

**QUANTUM**

# Section 4

**PARAMETERS**

## DETAILED PARAMETERS



**dbx**<sup>®</sup>  
PROFESSIONAL PRODUCTS

## 4.1 Multiband Compression

Within the multiband compressor menu on the QUANTUM the following parameters are user adjustable on all setups.

### Compressor LOC/On/Off

Local (per band control) or global on and off.

### Band 1 to 4 On/Off

Turns on or off each independent band

### OverEasy® 1-10 (per band or global)

The point when the QUANTUM (or any compressor) starts to compress is the "knee." When the QUANTUM starts to reduce the level of a signal abruptly right as it passes over the threshold this is called "hard knee" compression. OverEasy® (soft knee as it is sometimes called) is when the level of the signal is compressed gradually. OverEasy® compression starts to compress before the level of the signal reaches the threshold and reaches full compression after the volume has gone above the threshold. This OverEasy® compression by its very nature sounds much smoother and more natural and will be used for most applications. When it is gentle (natural sounding or light) compression that you are looking for, the QUANTUM has what we call VariKnee™. VariKnee™ gives you ten levels of OverEasy® compression to choose from (1 being almost hard knee and 10 being the most OverEasy®). This lets you choose the exact knee that is needed for the dynamic effect you are looking for.

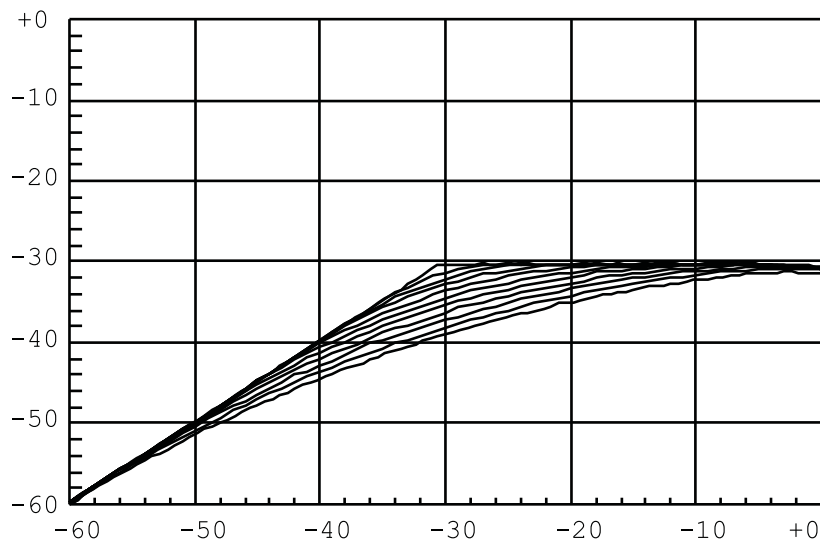

Fig. 4.1

### Auto LOC/On/Off and Auto On/Off

Auto can be turned on/off per band or globally. When Auto mode is on, the QUANTUM automatically sets the Attack, Hold, and Release times for the signal. The auto mode constantly adjusts these parameters in real time for optimum performance from the unit.

**4.1 Multiband Compression (cont.)****Threshold -60 to 0 dB (per band or global)**

Threshold is the signal level at which the QUANTUM starts to compress. If the threshold is set to -10 dBFS, then any signal larger than -10 dBFS is compressed, while any signal that has a level lower than -10dBFS is left at the same level. Light compression is where only the largest parts of the signal go over the threshold. Very heavy compression can be achieved by setting the threshold low enough so that almost the entire signal content is over the threshold. For most signals, the most natural compression is achieved when most of the signal content remains just below the threshold and only the peaks cross the threshold.

**Ratio 0.75 to Inf:1 (per band or global)**

Ratio is the amount the QUANTUM reduces the signal level of the sound that is above the threshold. A 2:1 ratio means that if the incoming signal is 2dB over the threshold the QUANTUM will compress the signal, and outputs a signal that only goes 1dB over the threshold. For light compression choose a lower ratio. For heavy compression a higher ratio is used. By setting the ratio at less than 1:1, the signal will be expanded rather than compressed. The QUANTUM will actually output a signal larger than the input. At a ratio of 0.75:1, if a signal goes over the threshold by 0.75dB the unit will output a signal that is 1 dB over the threshold.

**Gain -20 to +20 dB (per band or global)**

This is used to compensate for the gain lost during compression. By using heavy compression on a signal and then boosting the signal with the output gain we can then create a signal that sounds much louder than it was.

**Attack 0.1 m Sec to 200 m Sec (per band or global)**

Attack is how fast the compressor starts to compress the signal after it passes the threshold. Fast attack is useful when dealing with lots of fast transients. The attack control is not active when in auto mode.

**Hold 0 to 500 m Sec (per band or global)**

Hold is the time the QUANTUM remains in compression after the signal has dropped below the threshold. A longer hold time is useful in smoothing out the sound when compressing several fast peaks that are fairly close together in time. In general, some hold time helps to make the compression sound more natural but too much can over compress your signal making for an unwanted drop in level. The hold control is not active while in auto mode.

**Release 360 dB / Sec to 5 dB / Sec (per band or global)**

Release is how fast the QUANTUM comes out of compression. The release is in dB per second. For example, if release is set to 5 dB /sec, signal at 10dB of gain reduction, release time is 2 seconds. Too fast a release time can result in an audible volume jump, while too slow a release time can result in the compression of a signal that is not above the threshold. This can cause volume drops in your signal that may not be desired. The release control is not active while in auto mode.

## 4.2 Broadband Compression

The broadband compressor can be used in both stereo or dual mono configurations. Within the broadband compressor menu on the QUANTUM the following parameters are user adjustable on all setups.

### Compressor On/Off

Turns compressor module on and off.

### OverEasy® 1-10

The point when the QUANTUM (or any compressor) starts to compress is the "knee." When the QUANTUM starts to reduce the level of a signal abruptly right as it passes over the threshold this is called "hard knee" compression. OverEasy® (soft knee as it is sometimes called) is when the volume of the sound is compressed gradually. OverEasy® compression starts to compress before the level of the signal reaches the threshold and reaches full compression after the level has gone above the threshold. This OverEasy® compression, by its very nature sounds much smoother and more natural and will be used for most applications. When it is gentle (natural sounding or light) compression that you are looking for, the QUANTUM has what we call VariKnee™. VariKnee™ gives you ten levels of OverEasy® compression to choose from (1 being almost hard knee and 10 being the most OverEasy®). This lets you choose the exact knee that is needed for the dynamic effect you are looking for.

*see Fig. 4.1*

### Auto On/Off

When Auto Mode is on, the QUANTUM automatically sets the Attack, Hold, and Release times for the signal. The auto mode constantly adjusts these parameters in real time for optimum performance from the unit. You will find that for most applications, not only is using the auto mode faster and easier but by letting the unit constantly tweak these parameters for you will result in a better end result (try and hit a snare exactly the same for three minutes).

### Threshold -60 to 0 dB

Threshold is the signal level at which the QUANTUM starts to compress the signal. If the level is set to -10 dBFS, than any signal larger than -10 dBFS is compressed while any signal that has a level that is lower than -10dBFS is left at the same signal level. Light compression is where only the loudest parts of the signal go over the threshold. Very heavy compression can be achieved by setting the threshold low enough that almost the entire signal content is over the threshold. For most signals the most natural compression is achieved when most of the signal content remains just below the threshold and only the peaks cross the threshold.

### Ratio 0.75 to Inf:1

Ratio is the amount the QUANTUM reduces the signal level of the sound that is above the threshold. A 2:1 ratio means that if the incoming signal is 2dB over the threshold the QUANTUM will compress the signal, and outputs a signal that only goes 1dB over the threshold. For light compression choose a lower ratio, while for heavy compression a higher ratio is used. By setting the ratio at less than 1:1, the signal will be expanded. The QUANTUM will actually output a signal larger than the input. At a ratio of 0.75:1, if a signal goes over the threshold by 0.75dB, the unit will output a signal that is 1 dB over the threshold.



## 4.2 Broadband Compression (cont.)

### Gain -20 to +20 dB

This is used to compensate for the gain lost during compression. By using heavy compression on a signal and then boosting the signal with the output gain we can then create a signal that sounds much louder than it was.

### Attack 0.1 m Sec to 200 m Sec

Attack is how fast the compressor starts to compress the signal after it passes the threshold. Fast attack is useful when dealing with lots of fast transients. The attack control is not active when in auto mode.

### Hold 0 to 500 m Sec

Hold is the time the QUANTUM remains in compression after the signal has dropped below the threshold. A longer hold time is useful in smoothing out the sound when compressing several fast peaks that are fairly close together in time. In general some hold time helps to make the compression sound more natural but too much can over compress your signal making for an unwanted drop in level. The hold control is not active while in auto mode.

### Release 360 dB / Sec to 5 dB / Sec

Release is how fast the QUANTUM comes out of compression. The release is in dB per second. For example, if release is set to 5 dB /sec, signal at 10dB of gain reduction, release time is 2 seconds. Too fast a release time can result in an audible volume jump, while too slow a release time can result in the compression of signal that is not above the threshold. This can cause volume drops in your signal that may not be desired. The release control is not active while in auto mode.

## 4.3 Multiband Gate

A gate is a simple device. It is either open or closed. When a gate is open, signal is allowed to pass. When the gate is closed, signal is not allowed to pass. This lets you gate out background noise between tracks, cut the ring out of a drum, etc. Downward expansion works on much the same concept. Anything over a certain level is let by while any signal under that level is dropped in volume (expanded downward). The multiband gate on the QUANTUM lets you control the amount of gating/downward expansion separately in each frequency band range. Within the Expander/Gate menu on the QUANTUM the following parameters are user adjustable.

### Gate LOC/On/Off

Local (per band control) or global on and off.

### Band 1 to 4 On/Off

Turns on or off each independent band

### Threshold -75 to 0 dB (per band or global)

The threshold is the signal level at which the gate opens. Anything above the threshold passes, while signal that is lower than the threshold is attenuated. Beware, setting the threshold too high can cut off the tail end of signals as they fade out (the sustain of a guitar note, a held piano chord, a reverb tail, etc.).

### 4.3 Multiband Gate (cont.)

**Ratio 1:1.0 to 1:15 (per band or global)**

This is where you decide how much downward expansion you want. This ratio works backwards from that of the compressor or limiter. If a ratio of 1:4 is selected, a signal that is 1dB below the threshold will be reduced in level so that it becomes 4dB below the threshold.

**Attack 0.1 to 200 m Sec (per band or global)**

As the signal reaches the threshold area, the Attack control sets the speed at which the gate opens. Use very fast attack times to catch the fronts of transient signals.

**Hold 0 to 500 m Sec (per band or global)**

The Hold control sets the amount of time the gate is held open after the signal passes below the threshold point.

**Release 360 to 5 dB / Sec (per band or global)**

Release sets the speed at which the gate "closes" when the end of the Hold time is reached.

**Max ATT 0 to Inf. dB (per band or global)**

This sets the maximum amount of attenuation for the gate.

### 4.4 Broadband Gate

The QUANTUM's broadband gate is available in the non-multiband chain types. It works just like the multiband gate with the exception of the fact that it functions on the entire signal band.

Within the Expander/Gate menu on the QUANTUM when in non multiband chains the following parameters are user adjustable.

**Gate On/Off**

Local (per band control) or global on and off.

**Band 1 to 4 On/Off**

Turns on or off each independent band

**Threshold -75 to 0 dB**

The threshold is the volume level at which the gate opens. Anything above the threshold passes, while signal that is lower than the threshold is attenuated. Beware, setting the threshold to high can cut off the tail end of signals as they fade out (the sustain of a guitar note, a held piano chord, a reverb tail, etc.).

**Ratio 1:1.0 to 1:15**

This is where you decide how much downward expansion you want. This ratio works backwards from that of the compressor or limiter. If a ratio of 1:4 is selected, a signal that is 1dB below the threshold will be reduced in gain so that it becomes 4dB below the threshold.

**Attack 0.1 to 200 m Sec**

As the signal reaches the threshold area, the Attack control sets the speed at which the gate opens. Use very fast attack times to catch the fronts of transient signals.

#### 4.4 Broadband Gate (cont.)

**Hold 0 to 500 m Sec**

The Hold control sets the amount of time the gate is held open after the signal passes below the threshold point.

**Release 360 to 5 dB**

Release sets the speed at which the gate "closes" when the end of the Hold time is reached.

**Max ATT 0 to Inf. dB**

This sets the maximum amount of attenuation for the gate.

#### 4.5 Multiband Limiting

A Limiter works very much like a compressor. The only difference is that on a limiter the ratio is set at infinity to one.

Whenever a signal crosses the threshold the limiter compresses it back down. By using the multiband Limiter you can set each limiter differently for different frequency ranges. The multiband limiter is an RMS limiter, short transients may exceed the threshold.

With in the limiter menu on the QUANTUM the following parameters are user adjustable on all setups. (Changes made to factory setups can be saved as user setups.)

**Limiter LOC/On/Off**

Local (per band control) or global on or off.

**Bands 1 to 4 On/Off**

Lets you turn each band on or off independently.

**Threshold -60 to 0 dB (per band or global)**

This is at what level the limiter kicks in and says "NO LOUDER." It is recommended that the limiter's threshold be set to slightly below the point of no return so that there is a slight margin of safety. You, of course, want to be careful not to set the threshold to low as this would prevent you from getting the full dynamic range possible out of your gear. Finding the right limiter threshold for your equipment will take some experimentation. In a recording application most people will set the limiter up to prevent the signal from distorting the tape. Analog tape will saturate slowly and a higher threshold will let you take advantage of this if you choose to. Digital recording is far less forgiving and a correctly set limiter threshold will prevent any ugly digital overs from ruining a take. By dropping the threshold down below the bulk of the signal level we can then be limiting all the time. This will effectively take all the dynamics out of a signal and is used as a form of extra heavy compression.

**OverEasy® Off to 10 (per band or global)**

There are ten levels of OverEasy® that can be used on the QUANTUM's limiters

**Auto On/Off/LOC and On/Off**

When auto is turned on the QUANTUM will continuously set the attack / hold / release controls itself. It can be set globally or locally per band.

### 4.5 Multiband Limiting (cont.)

#### Attack .01 to 200 m Sec (per band or global)

This is the speed at which the QUANTUM limiter starts to compress the signal once it has crossed the threshold. Set the attack time longer for lower frequency bands, and shorter for higher frequency bands.

#### Hold 0 to 500 m Sec (per band or global)

Hold is the time the limiter stays in gain reduction after the signal level has dropped below threshold. Hold is useful when you want the limiter to function for a period of time after it has been triggered. **Be careful not to set the hold time too long as it will not release in time.**

#### Release 360 to 5 dB / Sec (per band or global)

Just like the release time on the compressor, the limiter's release time controls how fast the limiter releases from gain reduction after the signal drops below the threshold. Set the release times longer for lower frequency bands and shorter for higher frequency bands.

### 4.6 Broadband Limiting

The broadband limiter works very much like the multiband limiter. The main difference being that it is a single limiter for the entire frequency range.

Within the limiter menu on the QUANTUM when in non-multiband stereo mode the following parameters are user adjustable on all setups.

#### Limiter On/Off

Turns limiter on and off.

#### Threshold -60 to 0 dB

As in the multiband limiter, this is at what level the limiter kicks in and says "NO LOUDER." It is recommended that the limiter's threshold be set to slightly below the point of no return, so that there is a slight margin of safety. Of course, be careful not to set the threshold too low. Finding the right limiter threshold for your equipment will take some experimentation. In a recording application most people will set the limiter up to prevent the signal from distorting the tape. Analog tape will saturate slowly and a higher threshold will let you take advantage of this if you choose to. Digital recording is far less forgiving and a correctly set limiter threshold will prevent any ugly digital overs from ruining a take. For sound reinforcement uses, the QUANTUM's limiter is perfect for keeping your amplifiers from clipping. When an amplifier clips it sends square waves through to the speakers, and this can damage a speaker very quickly. The limiter can also sometimes be used as an effect. Setting the threshold low will effectively take all the dynamics out of a signal and is used as a form of extra heavy compression.

#### Type PkStop+/RMS

This lets you select the type of limiter used. An RMS limiter limits the signal based on the average signal level. While this is a much more musical sounding limiter, some fast transients may go beyond the limiter threshold. The PeakStop® + will keep all peaks below the set threshold.

#### Attack .01 to 200 m Sec (per band or global)

This is the speed at which the QUANTUM limiter starts to compress the signal once it has crossed the threshold. Set the attack time longer for lower frequency bands, and shorter for higher frequency bands.

### 4.6 Broadband Limiting (cont.)

#### Hold 0 to 500 m Sec (per band or global)

Hold is the time the limiter stays in gain reduction after the signal level has dropped below threshold. Hold is useful when you want the limiter to function for a period of time after it has been triggered. **Be careful not to set the hold time too long as it will not release in time.**

#### Release 360 to 5 dB / Sec (per band or global)

Just like the release time on the compressor, the limiter's release time controls how fast the limiter releases from gain reduction after the signal drops below the threshold. Set the release times longer for lower frequency bands and shorter for higher frequency bands.

### 4.7 EQ

There are 5 bands of EQ on the QUANTUM that can be used for something as subtle as sweetening a mix to drastic changes. Bands 1 and 5 are shelves while 2 through 4 are fully parametric.

Within the EQ menu the following parameters are user adjustable.

#### EQ On/Off

This control turns all 5 bands on and off.

#### POS Pre/Post

This sets the position of the EQs in the chain. The EQ can be Pre or Post dynamic processors. This is a global control as all bands must be either pre or post as a group.

#### Type Const Q / Adapt Q

This controls effects all 5 bands.

Const Q operates similar to an analog graphic EQ where the Q is constant regardless of cut or boost. Whereas, Adaptive Q, operates similar to the EQ that is found on a mixing console where the width of the band is constant regardless of the cut or boost.

The following figure shows the difference between constant and adaptive Q parametric filters.

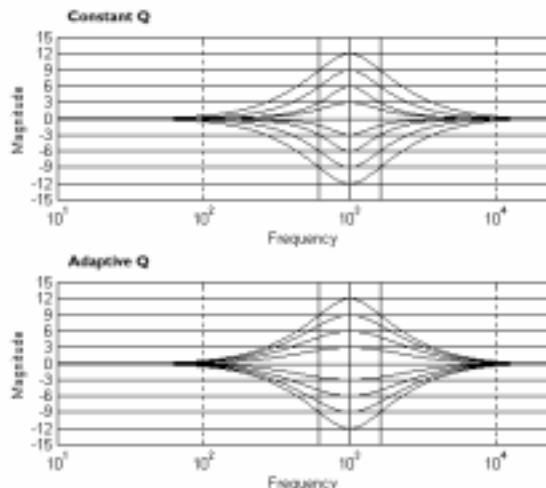

Fig. 4.2

**4.7 EQ (cont.)****Band 1 FC 20.0 Hz to 20.0 kHz**

This controls the corner frequency for the low frequency shelving EQ band.

**Slope 3 to 12 dB / Octave**

Sets the slope of the shelf.

**Level -12 to + 12 dB**

Amount of boost or cut. Adjustable in 1/2 dB steps.

**Band 2, 3, 4 FC 20.0 Hz to 20.0 kHz**

This controls the center point for the parametric EQ.

**Q 0.25 to 16.0**

Sets the width of the boost / cut.

**Level -12 to + 12 dB**

Amount of boost or cut. Adjustable in 1/2 dB steps.

**Band 5 FC 20.0 Hz to 20.0 kHz**

This controls the corner frequency for the high frequency shelving EQ band.

**Slope 3 to 12 dB / Octave**

Sets the slope of the shelf.

**Level -12 to + 12 dB**

Amount of boost or cut. Adjustable in 1/2 dB steps.

**4.8 XOver**

There are three crossover points on the QUANTUM, creating 4 bands. Tuning them allows you to select which frequencies to process with which of the multiband dynamics processors. The QUANTUM uses phase compensated, Butterworth 1st and 3rd order filters.

Within the crossover menu on the QUANTUM, the following parameters are user adjustable:

**Edge 1 Fc 20.0 Hz to 5.0 kHz**

Sets the crossover point between bands 1 and 2.

**Edge 2 Fc 40.0 Hz to 10.0 kHz**

Sets the crossover point between bands 2 and 3.

**Edge 3 Fc 79.0 Hz to 20.0 kHz**

Sets the crossover point between bands 3 and 4.

**Slope 6 or 18 dB / Octave (per band)**

Your choice of 2 different slopes for each of the 3 crossover points.

### 4.9 SEQ

When in the broadband mode, not only do you have access to the equalizer but also another EQ in the sidechain. Having EQ in the sidechain lets you boost or cut various frequencies prior to the dynamics processor detector. Cutting low-end in the sidechain will mean the detection circuit will see less low-end, thus the signal will be compressed based on it's high frequency content.<sup>o</sup>

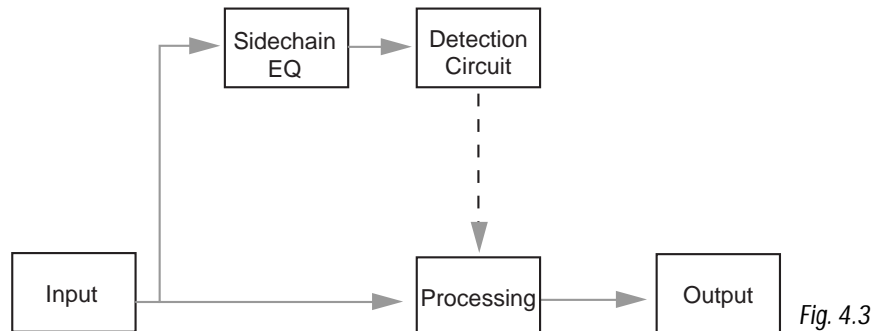

Within the SEQ menu on the QUANTUM the following parameters are user adjustable: Press the EQ/XOVER button twice when in non-multiband mode to access the SEQ.

#### Schain EQ On/Off

This control turns all 5 bands on/off.

#### Type Const Q / Adapt Q

This controls all 5 bands. All bands must use the same Q type.

#### SEQ1 FC 20.0 Hz to 20.0 kHz

This controls the corner frequency for the low frequency shelving EQ band.

#### Slope 3 to 12 dB / Octave

Sets the slope of the shelf.

#### Level -12 to + 12 dB

Amount of boost or cut. Adjustable in 1/2 dB steps.

#### SEQ2, 3, 4 FC 20.0 Hz to 20.0 kHz

This controls the center point for the parametric EQ.

#### Q 0.25 to 16.0

Sets the width of the boost / cut.

#### Level -12 to + 12 dB

Amount of boost or cut. Adjustable in 1/2 dB steps.

#### SEQ5 FC 20.0 Hz to 20.0 kHz

This controls the corner frequency for the high frequency shelving EQ band.

#### 4.9 SEQ (cont.)

**Slope 3 to 12 dB / Octave**

Sets the slope of the shelf.

**Level -12 to + 12 dB**

Amount of boost or cut. Adjustable in 1/2 dB steps.

#### 4.10 Type IV™

The QUANTUM uses dbx Type IV™ 96 kHz converters. Type IV™ gives you more A to D headroom and the ability to add Tape Saturation Emulation. (For more information on Type IV™ and TSE™, see the *White Paper* on page 65 of Appendix B).

**Type IV™ On/Off**

This turns Type IV™ on and off. When turned off, the QUANTUM's A to D converters work as standard 24-bit 96 kHz converters. Note that this can be controlled independently in dual mono programs.

**Color**

This sets the color or tone of the Type IV™ conversion system. The following options are available:

**Bright** Very bright and airy up top.

**Light** Not as much sizzle in the top but less aggressive on harsh mixes.

**None** No coloration.

**Warm** For that warm, and friendly feel.

**Dark** Enhances low frequencies—good for an “bright” mix.

**Level -4 to 0**

Sets the signal level at which the Type IV™ conversion system starts to work.

#### 4.11 Stereo Adjust

The “Stereo Adjust” control lets you change the width of the stereo mix. Within the “Other” menu the following parameters are user adjustable:

**St Adj On/Off**

I think you get it by now, turns it on, turns it off.

**Balance -100% to +100%**

This lets you adjust the panning of your signal from one side to the other. 0% is center, so -100% becomes extreme left and +100% becomes extreme right.

**M-S 100% to +100%**

This controls the width of your stereo image. 0% is untouched so -100% becomes the narrowest (mono) while +100% become the widest possible stereo image.



## 4.12 Ambience

Ambience uses a combination of gain and compression to enhance low level information. Reverb tails and acoustic guitar finger picking are examples of sounds that can be enhanced by using the Ambience effect.

### Ambience On/Off

Sort of self explanatory by now.

### Amount 1.0:1 to 5:1

This sets the amount of ambience.

### Width 10 to 30 dB

This controls the portion of the signal that the ambience is applied to.

### Thresh -60 to 0 dB

Sets the threshold of the ambience processor.

## 4.13 TCM™

Transient Capture Mode or TCM™ was first seen in the dbx 172 Super Gate. Basically what it does is delay the input of the VCA enough that the detector is able to read ahead in the signal. With a long enough TCM™ time it is possible to have a gate start to open or compressor start to compress before the signal hits the VCA. This can be used to achieve very intelligent limiting and gating along with very smooth and transparent compression. Once the TCM™ is turned on it works on the compressor, gate and limiter while in both multiband and broadband modes. To keep the multiband dynamic elements phase coherent, there is only one TCM™ time for all bands of the gate, compressor, and limiter.

### TCM™ On/Off

This is a global control and turns the TCM™ on or off for all compressors, limiters, and gates.

### Time 0 to 85 m Sec

This sets the amount of the TCM™ delay. The longer the time, the more time the unit has to react to fast transient peaks. Care must be used however as a long TCM™ time coupled with a fast release on the compressor or limiter can cause them to release before the peak even hits.

## 4.14 De-Esser

The De-Esser is only available in non-multiband chains, e.g., Stereo Broadband or Dual Mono. A De-Esser is primarily used to remove the "S" or sibilant sounds in a vocal track.

Within the De-Esser menu the following parameters are user adjustable:

### De-Esser On/Off

You guessed it. Turns the De-Esser on or off

### Freq. 800 Hz to 8.00 kHz

This is the center frequency the De-Esser uses when in Band Pass mode or the corner frequency used when in High Pass mode.

**4.14 De-Esser (cont.)****Amount 0 to 100%**

This controls the amount of De-Essing. The amount control is very much like a combination threshold / ratio control. A higher amount applies more De-Essing to the signal.

**Type HP or BP**

Selects the type of filter used by the De-Esser.

**Width**

Sets the Q of the Band Pass Filter.

**4.15 Normalization**

The Normalizer in the QUANTUM adds gain to the signal right before the output. By adding gain to the signal right at the end of the chain we can then make sure that it goes to tape, disk, etc., as "hot" as possible.

The gain optimize function automatically adjusts the QUANTUM's gain to maximize output without going over 0dBFS. The gain optimize function sets the output gain of the QUANTUM by "looking" at a sample of music and keeping track of the highest level of that audio signal. The output gain is then set so that the highest level reaches, but does not go over 0 dBFS. The gain optimize can be accessed from the Normalizer, by pressing the EDIT ALL/BAND button. This starts the gain optimize sample period. The EDIT ALL/BAND button must be pressed to complete the gain optimize sample period. EDIT ALL/BAND and PROGRAM are the only buttons that will allow the user to exit the gain optimize. As the gain is being optimized, the output gain is set to -12 dBFS to compensate for any peaks in the program material. If the PROGRAM button is pressed during the gain optimize operation, the output gain level will be set to it's previous level and the QUANTUM will go back to the program mode.

Within the NORM/OUTPUT menu the following parameters are user adjustable:

**Normalize On/Off**

Turns the Normalizer on or off.

**Level -12 dB to +12 dB**

The final output stage of the QUANTUM. This lets you adjust the final volume you send out of the unit.

**Ceiling -3.0 to 0.0 dBFS**

This parameter allows you set the overall output ceiling level of normalization.

**4.16 Output****Bits 8 to 24**

The selection of the QUANTUM's final output word length. 8, 16, 20, or 24-bit word lengths can be selected.

*See Figure H-1 in the Appendix, pg. 81*

**Dither SNR<sup>2</sup> / HPTPDF / TPDF / OFF**

Select from one of 3 dither algorithms. HPTPDF and TPDF are the text book versions, SNR<sup>2</sup> is the dbx proprietary dither algorithm.

**4.16 Output (cont.)****Shaping S1 or S2**

This lets you change between the 2 different digital noise shape algorithms.

*See Figure H-2 in the Appendix, pg. 82*

**Dither Out - All or Digital**

Sets the routing of the Dither output. When All is selected, the Dither is routed to the digital outputs and the D/A. When the Dither Out is set to Digital, the dithered signal is sent to the digital outputs and the full 24-bit output is sent to the D/A.



### F.1 Factory Programs

- 1) Pop Master1
- 2) Piano Track
- 3) Studio Voc / Acoustic Gt
- 4) Country Mix
- 5) Classical CD
- 6) Squash It
- 7) Expand It
- 8) Funkngroove
- 9) Jazz Master
- 10) Smooth Voc
- 11) Rockin CD
- 12) Mix Maximum
- 13) RAP It Up
- 14) Ballad CD 2
- 15) DanceMaster
- 16) Demo CD 1
- 17) Kick Track
- 18) Ambient CD
- 19) Telephone
- 20) Rock Master
- 21) Hip Hop CD
- 22) Techno Mix
- 23) Ballad CD 1
- 24) World Mix
- 25) Folk Master
- 26) Subtle Mix
- 27) Live CD
- 28) Country CD
- 29) Cass. To CD
- 30) Default MB
- 31) Drum Room
- 32) ST E Gtr
- 33) ST Vocal
- 34) Horn Sec.
- 35) Piano Room
- 36) String Sec.
- 37) ST Ac Gtr
- 38) Orchestral
- 39) Synth Track
- 40) Default ST
- 41) Fat Kick / Slam Snare
- 42) Brite Snare / Brite Horns
- 43) Small Voc / Big Piano
- 44) Thick Kick / Tight Toms
- 45) Rim Shot / Ringing Tom
- 46) R&B Vocal / Slap Bass
- 47) De-ess Voc / Monster Gtr
- 48) Country Voc / Twang E Gtr
- 49) Rumble Bass / FunkstompGt
- 50) Mono Def. / Mono Def.

- 51) Pop Master1
- 52) Piano Track
- 53) Studio Voc / Acoustic Gt
- 54) Country Mix
- 55) Classical CD
- 56) Squash It
- 57) Expand It
- 58) Funkngroove
- 59) Jazz Master
- 60) Smooth Voc
- 61) Rockin CD
- 62) Mix Maximum
- 63) RAP It Up
- 64) Ballad CD 2
- 65) DanceMaster
- 66) Demo CD 1
- 67) Kick Track
- 68) Ambient CD
- 69) Telephone
- 70) Rock Master
- 71) Hip Hop CD
- 72) Techno Master
- 73) Ballad CD 1
- 74) World Mix
- 75) Folk Master
- 76) Subtle Mix
- 77) Live CD
- 78) Country CD
- 79) Cass. To CD
- 80) Default MB
- 81) Drum Room
- 82) ST E Gtr
- 83) ST Vocal
- 84) Horn Sec.
- 85) Piano Room
- 86) String Sec.
- 87) ST Ac Gtr
- 88) Orchestral
- 89) Synth Track
- 90) Default ST
- 91) Fat Kick / Slam Snare
- 92) Brite Snare / Brite Horns
- 93) Small Voc / Big Piano
- 94) Thick Kick / Tight Toms
- 95) Rim Shot / Ringing Tom
- 96) R&B Vocal / Slap Bass
- 97) De-ess Voc / Monster Gtr
- 98) Country Voc / Twang E Gtr
- 99) Rumble Bass / FunkstompGt
- 100) Mono Def. / Mono Def.

**F-2 Factory Setups****Stereo:**

Default MB  
Default ST  
Mix Maximum  
Country Mix  
Folk Master  
Subtle Mix  
Pop Master1  
Pop Master2  
Classical CD  
Funkngroove  
Rock Master  
Country CD  
Jazz Master  
Cass. To CD  
Ambient CD  
Smooth Voc  
Rockin CD  
World Mix  
Squash It  
Expand It  
Metal CD  
Telephone  
Hip Hop CD  
RAP It Up  
Ballad CD 1  
Ballad CD 2  
DanceMaster  
Techno Mix  
Demo CD 1  
Demo CD 2  
Kick Track  
Live CD  
Choral Ens.  
Piano Track  
ST E Gtr  
Drum Room  
ST Vocal  
Piano Room  
ST Ac Gtr  
String Sec.  
Synth Track  
Horn Sec.  
Orchestral

**Mono:**

Mono Def.  
R&B Vocal  
Studio Voc  
Small Voc  
Country Voc  
De-ess Voc  
Fat Kick  
Thick Kick  
Brite Snare  
Slam Snare  
Rim Shot  
Tight Toms  
Ringing Tom  
Rumble Bass  
Slap Bass  
Big Piano  
Brite Horns  
Acoustic Gt  
Folk Gtr  
Twang E Gtr  
Monster Gtr  
FunkstompGt

## Specifications

### Inputs

Connectors:	Female XLR and 1/4" TRS (Pin 2 and tip hot)
Type:	Electronically balanced/unbalanced, RF filtered
Impedance:	Balanced >18 k $\Omega$ , unbalanced >9 k $\Omega$
Max Input Level:	+24 dBu balanced or unbalanced
CMRR:	>40 dB, typically >55 dB at 1 kHz
Input Gain Range:	$-\infty$ to +16 dB
MIDI:	5-Pin DIN MIDI Input Jack

### Outputs

Connectors:	Male XLR and 1/4" TRS (Pin 2 and tip hot)
Type:	Servo-balanced/unbalanced, RF filtered
Impedance:	Balanced 120 $\Omega$ , unbalanced 60 $\Omega$
Max Output Level:	>+21dBu balanced/unbalanced into 2k $\Omega$ or greater >+20dBm balanced/unbalanced (into 600 $\Omega$ )
Output Gain Range:	$-\infty$ to +16 dB
MIDI:	5-Pin DIN MIDI Out/Thru Jack

### A-D System Performance

A-D Conversion:	24-bit, dbx Type IV™ Conversion System
Convertor Dynamic Range:	114 dB typical, A-weighted, 22 kHz bandwidth 112 dB typical, unweighted, 22 kHz bandwidth
Type IV™ Dynamic Range:	Up to 127 dB with transient material, A-weighted, 22 kHz bandwidth Up to 125 dB with transient material, unweighted, 22 kHz bandwidth Typically 119 dB with program material, A-weighted, 22 kHz bandwidth Typically 117 dB with program material, unweighted, 22 kHz bandwidth
THD+Noise:	0.002% typical at +4 dBu, 1 kHz, input gain at 0 dB
Frequency Response:	20 Hz to 20 kHz, +0/-0.5 dB
Interchannel Crosstalk:	< -85 dB at 1 kHz, input gain at 0 dB

### D-A System Performance

D-A Conversion:	24-bit
Dynamic Range:	115 dB typical, A-weighted, 22 kHz bandwidth 112 dB typical, unweighted, 22 kHz bandwidth
THD+Noise:	0.002% typical at +4 dBu, 1 kHz, output gain at 0 dB
Frequency Response:	20 Hz to 20 kHz, +0/-0.5 dB
Interchannel Crosstalk:	< -85 dB at 1 kHz, output gain at 0 dB

## TPDF Dither

Audio Precision

FFT SPECTRUM ANALYSIS, DIGITAL

05/05/99 23:33:14

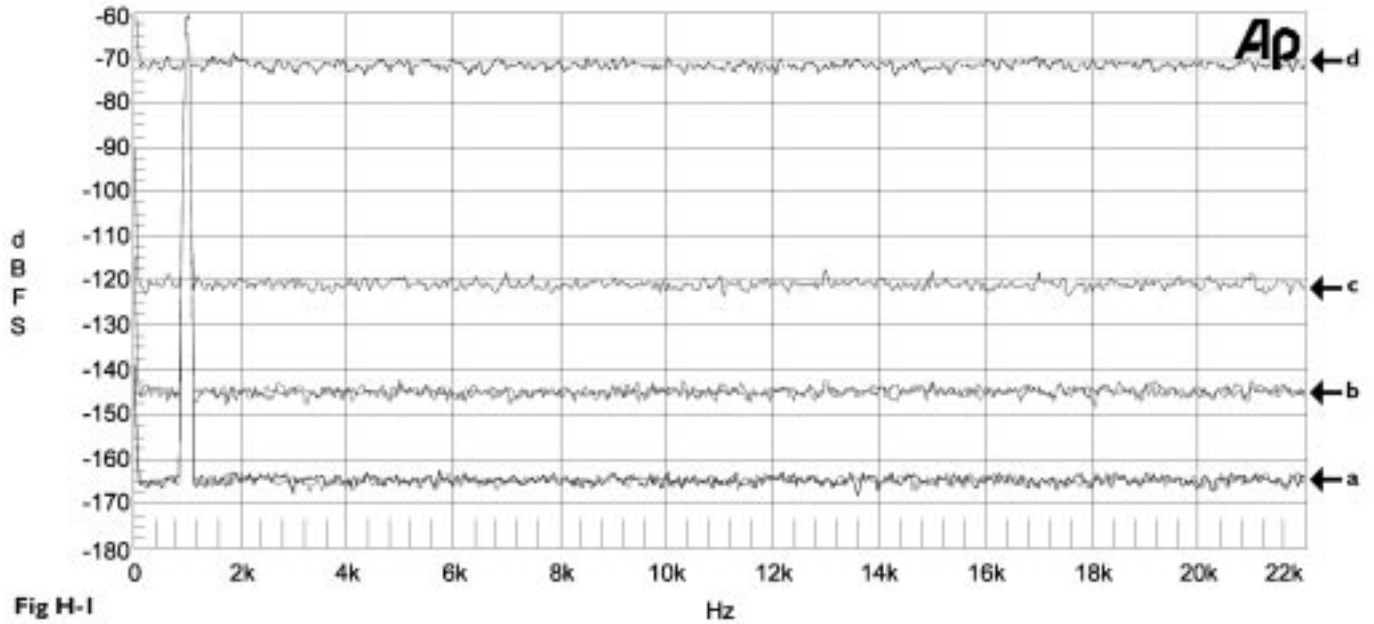

TPDF Dither. (a) 24-Bit word output, (b) 20-Bit word output, (c) 16-Bit word output (d) 8-Bit word output. Parameters: Input -60dBFS, 1 kHz; FFT Length= 2048, Sample Rate= 48 KHz, Averages= 32; Graph Steps= 1024.



## Noise Shaping

Audio Precision

FFT SPECTRUM ANALYSIS, DIGITAL

05/05/99 23:20:36

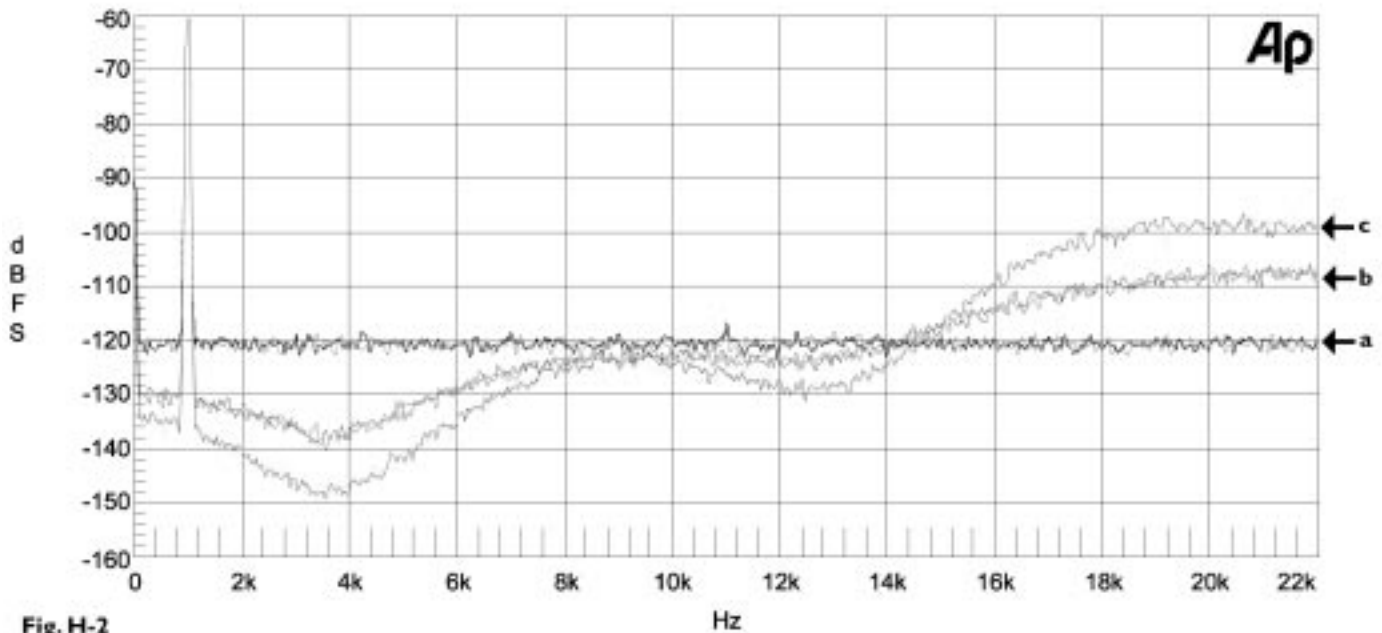

Fig. H-2

16-Bit TPDF dither. (a) Shape "off", (b) with shape set to "S1", (c) with shape set to "S2." Parameters: Input -60dBFS, 1 kHz; FFT Length= 2048, Sample Rate= 48 KHz, Averages= 32; Graph Steps= 1024.

## Truncation

Audio Precision

FFT SPECTRUM ANALYSIS, DIGITAL

05/05/99 23:35:36

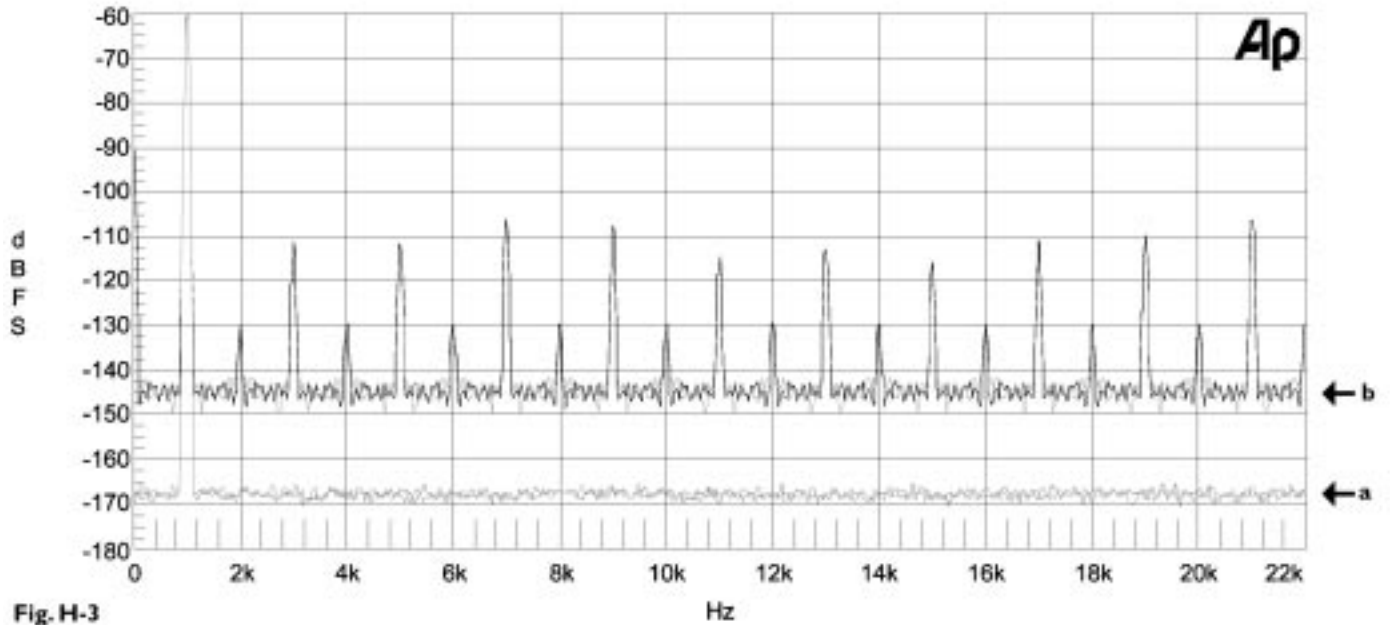

Fig. H-3

(a) 24-Bit word, (b) 16-Bit truncated output, no dither. Parameters: Input -60dBFS, 1 kHz; FFT Length= 2048, Sample Rate= 48 KHz, Averages= 32; Graph Steps= 1024.



***PROFESSIONAL PRODUCTS***

**H** A Harman International Company

8760 South Sandy Parkway

Sandy, Utah 84070

Phone: (801) 568-7660

Fax (801) 568-7662

Int'l Fax: (219) 462-4596

Questions or comments?

E-mail us at: [customer@dbxpro.com](mailto:customer@dbxpro.com)

or visit our World Wide Web home page at:

[www.dbxpro.com](http://www.dbxpro.com)